



OWNER'S MANUAL

FOR THE TURBOCHEF DOUBLE BATCH RAPID COOK OVEN



For further information, call
800.90TURBO
or
+1 214.379.6000

Original Instructions

The information contained in this manual is important for the proper installation, use, maintenance, and repair of this oven. Follow these procedures and instructions to help ensure satisfactory cooking results and years of trouble-free service.

Errors – descriptive, typographic, or pictorial – are subject to correction. Specifications are subject to change without notice.

Please carefully read this manual and retain it for future reference.

Table of Contents

Important Safety Instructions

General Safety Information	i
Reducing Fire Risk	i
Grounding Instructions	ii
Power Cord Replacement	ii
Protective Earth (Ground) Symbol	ii
Equipotential Bonding Symbol	ii

Specifications and Installation

Theory of Operation	1
Features	1
Dimensions	1
Certifications	2
Oven Construction	2
Electrical Specifications	2
Installation	2
Unpacking Instructions	2
Installation Warnings - Read Before Lifting Oven	2
Lifting and Placing the Oven	3
Installation Near Open Heat Source	3
Oven Restraint Kit	4
ChefComm OneTouch®	4
Open Kitchen [†]	4
Date and Time Prompt	4
Voltage Selection	4
Ventilation	4

Cleaning

Daily Maintenance	5-6
Weekly Maintenance	7-8

OneTouch Controller Operation

Oven Controls: OneTouch	9
Recipe Mode	10-14
Manual Cook Mode	15
Oven Settings	15
Master Volume	15
Menu Edit	15
Manual Cook	15
Demo Mode	15

Menu Download	15
Temperature Units (C/F)	15
Show Grid/List View Toggle	15
F2 Bypass	16
Language	16
Date/Time/Time Format	17
Reboot	17
Network	17
Load Menu from USB: OneTouch Controller	17
Save Menu to USB: OneTouch Controller	17
Edit Mode: OneTouch	18
Creating a Group	18-19
Editing a Group	19
Creating a Recipe	20-22
Adding a Recipe to a Group	22-23
Editing a Recipe	23
Instructions for Receipt Cooking at Different Temperatures	24
Example #1	24-26
Example #2	26-27
Option A	27-28
Option B	28-29

LEGACY CONTROLLER OPERATION

Oven Controls: Legacy	30
Menu Cook Mode	31-32
Manual Cook Mode	33
Info Mode	34
Information Screen	34
Counters Screen	34
Counters Screen - Fault Log	
Options Screen	35
Editing	35
Cook More	35
Load Menu	35
VAC	35
Demo Mode	35
Manual Cooking	35
Diagnostic Mode	35
F2 Bypass	35
Settings Screen	35
Temperature Measurement	35

Language	35
WiFi Network	36
SSID	36
Security Type	36
Wifi Password	36
Channel	36
MAC IP	36
Settings Screen - Volume	36
Settings Screen - Date	37
Settings Screen - Time	37
Service Screen	37
MFG Screen	37
Edit Mode	37
Edit Set Temperature	37
Edit Item Settings and Menu/Group/Item Names	37
Menu/Group/Item Name	37
Event % Time	37
Event % Air	37
Increase and Decrease	37
Total Cook Time	37
Set Cook Time Icons	38
Cancel	38
Save	38
Cook	38
Loading and Saving Menus	39
Troubleshooting	40-41
North America Limited Warranty	42-43
International Limited Warranty	44-45

IMPORTANT SAFETY INSTRUCTIONS

⚠ WARNING: When operating this oven, strictly adhere to the following safety precautions to reduce the risk of burns, electric shock, fire, injury, damage to oven or property near oven.

GENERAL SAFETY INFORMATION

- ✓ Read all instructions before using this appliance.
- ✓ This appliance must be grounded. Connect only to a properly grounded outlet. See “Grounding Instructions” on page ii.
- ✓ Install or locate this appliance only in accordance with the provided installation instructions.
- ✓ This appliance should be serviced by qualified service personnel only. Contact the nearest authorized service facility for examination, repair, or adjustment.
- ✓ Keep the cord away from heated surfaces.
- x DO NOT use corrosive chemicals or vapors in this appliance; it is not designed for industrial/laboratory use.
- x DO NOT allow children to use this appliance.
- x DO NOT operate this appliance if it has a damaged cord or plug, is not working properly, or has been damaged or dropped. See “Power Cord Replacement” found on page ii.
- x DO NOT cover or block any openings on this appliance.
- x DO NOT store this appliance outdoors.
- x DO NOT use this product near water (e.g., near a kitchen sink, in a wet basement, near a swimming pool).
- x DO NOT immerse the cord or plug in water.
- x DO NOT let the cord hang over the edge of a table or counter.
- x DO NOT use a water jet for cleaning.
- x **WARNING:** Due to the nature of the appliance, the floors around it may be slippery.
- x This appliance is not to be used by children or persons with reduced physical, sensory or mental capabilities, or lack of experience and knowledge, unless they have been given supervision or instruction.

REDUCING FIRE RISK

- ✓ If materials inside the oven ignite, keep the oven door closed, turn the oven off, and disconnect the power cord or shut off power at the fuse or circuit breaker panel.
- ✓ If smoke is observed, switch off or unplug the oven. Keep the door closed to stifle any flames.
- x DO NOT use the cook cavity for storage purposes.
- x DO NOT overcook food. Carefully attend to the oven if paper, plastic, or other combustible materials are placed inside the oven to facilitate cooking.
- x DO NOT leave paper products, cooking utensils, or food in the cavity when the oven is not in use.

SAVE THESE INSTRUCTIONS

GROUNDING INSTRUCTIONS

This appliance must be grounded. In the event of an electrical short circuit, grounding reduces the risk of electric shock by providing an escape wire for the electric current. This oven is equipped with a cord that has a grounding wire with a grounding plug, which must be plugged into an outlet that is properly installed and grounded. Consult a qualified electrician or serviceman if uncertain about the ability to follow grounding instructions or if in doubt as to whether the appliance is properly grounded.

- x DO NOT use an extension cord. If the power cord is too short, have a qualified electrician or serviceman install an outlet near the appliance.

 **WARNING:** Improper grounding can result in risk of electric shock.

POWER CORD REPLACEMENT OR REMOVAL

If the power cord is damaged, it must be replaced by the manufacturer, its service agent, or a similarly qualified person.

 **WARNING:** If the oven is unplugged during service or maintenance, the user must be able to access and see the plug at all times to ensure that the oven remains unplugged. The plug must remain near the oven and cannot be placed behind another appliance or in another room.

PROTECTIVE EARTH (GROUND) SYMBOL

 This symbol identifies the terminal which is intended for connecting an external conductor for protection against electric shock in case of a fault, or the terminal of a protective earth (ground) electrode.

EQUIPOTENTIAL BONDING SYMBOL

 This symbol identifies the terminals which, when connected together, bring the various parts of an equipment or of a system to the same potential, not necessarily being the earth (ground) potential, e.g. for local bonding.

SAVE THESE INSTRUCTIONS

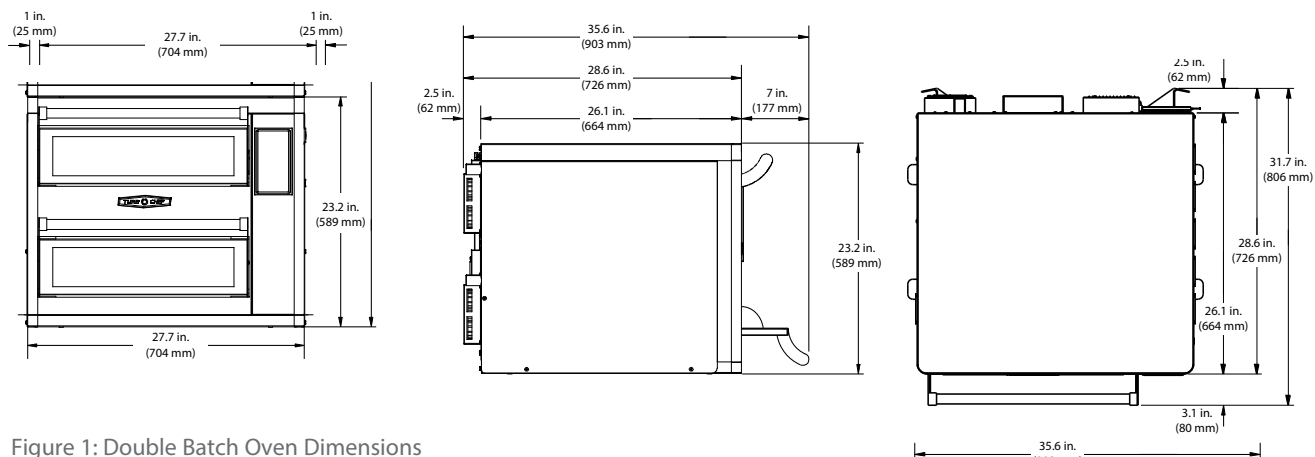

Figure 1: Double Batch Oven Dimensions

Theory of Operation

Utilizing TurboChef's patented technology to rapidly cook food without compromising quality, the Double Batch oven provides superior cooking performance while requiring minimal space and energy consumption. The oven circulates impinged air at speeds of up to 60 mph to create high heat transfer rates and reduce cook time. The technology includes utilizing a variable speed blower, oscillating rack, and catalytic converter, resulting in minimal energy input, high food quality, and UL®-certified ventless operation (see page 4 for details).

This manual includes instructions for installing, cleaning, and operating Double Batch ovens. If you have questions that are not addressed in this manual, contact Customer Support at 800.90TURBO (+1 214.379.6000) or your Authorized Distributor.

Features

- Simple and intuitive touch controls
- Multi-language user interface
- Variable-speed High h recirculating air impingement system
- Oscillating rack for high heat transfer without spotting
- Half-sheet pan/16-inch pizza capacity
- Stackable design (requires stacking kit)
- Smart menu system capable of storing up to 800 recipes: 400 recipes per cavity
- Built-in self diagnostics for monitoring oven components and performance
- USB and Open Kitchen ready

Dimensions

Oven Dimensions

- Height (single oven): 23.2" (589 mm)
- Width: 27.7" (704 mm)
- Depth (door closed): 31.7" (806 mm)
- Depth (door open): 35.6" (903 mm)
- Weight: 262 lb. (119 kg)

Cook Cavity Dimensions

- Height: 3.3" (84 mm)
- Width: 18.1" (318 mm)
- Depth: 17.07" (434 mm)
- Volume: 0.59 cu.ft. (16.7 liters)

Clearances

- Top: 2" (51 mm)
- Sides: 2" (51 mm)

Certifications



cULus, UL EPH, FDA, TÜV, CE

Oven Construction

Exterior

- Stainless steel front, top, and sides
- Rubber seal for surface mounting

Interior

- 304 stainless steel
- Fully insulated cook chambers
- Top and bottom jetplates

Electrical Specifications

TurboChef recommends a Type D circuit breaker for all installations outside the United States.

Single Phase

US/Canada: 208/240 VAC*, 60 Hz, 45 A, 10.6 kW

3 Phase Delta

US/Canada: 208/240 VAC*, 60 Hz, 30 A, 10.6 kW

- * US/Canada models include a voltage sensor that detects 208 or 240 VAC, but does not compensate for lack-of or over-voltage installations.

Installation

Install or locate this appliance only in accordance with the instructions below.

Unpacking Instructions

1. Remove the oven from its packaging.
2. Before discarding, check the packaging thoroughly for accessories and literature.

NOTE: Packaging may also be retained in case the oven may at some point be shipped somewhere else or returned to the manufacturer.

3. Check the cook cavity thoroughly for accessories, and literature.
4. Discard any packaging in the cook cavities.

Installation Warnings - Read Before Lifting Oven

⚠ WARNING: The Double Batch oven weighs approximately 262 lb. (119 kg). Never lift with fewer than two people.

⚠ WARNING: Never lift the oven from the front and rear or by the door handle. Doing so will cause the door to misalign, resulting in a non-warranty service call.

⚠ WARNING: The oven must be properly placed on a food station at all times. TurboChef will not recognize a fallen oven as a warrantable claim and is not liable for any injuries that may result.

⚠ WARNING: This oven is not intended for built-in installation (i.e., installing the oven in any structure that surrounds the oven by five or more sides). Be sure to provide a minimum of 2" (51 mm) clearance for all sides and 2" (51 mm) clearance for the top.

⚠ WARNING: This oven is not intended to be stacked without appropriate hardware. Contact TurboChef for details.

Lifting and Placing the Oven

1. Prepare a surface at least 28.6" (726 mm) deep and capable of supporting 262 lb. (119 kg).
2. Position one or more persons at the left and right sides of the oven.
3. Place hands under the oven and lift.
4. Place the oven on the prepared surface, ensuring no edges are hanging off the sides.
5. Ensure the oven rack is properly installed. When properly installed, the rack rests on oscillating pins.
6. Plug in the oven.

Installation Near Open Heat Source

When placing a TurboChef oven near an open heat source (Figure 2), strictly adhere to the following:

- If the oven is being placed near a grill or stove, a divider must exist between the oven and the open heat source, with a minimum of 6" (152 mm) between the oven and the divider.
- If the oven is being placed near a fryer, a divider must exist between the oven and fryer, with a minimum of 12" (305 mm) between the oven and the divider.
- The height of the divider must be greater than or equal to the height of the oven, (23.2" or 589 mm).
- Verify the oven location has a minimum 2" (51 mm) clearance on top and a minimum 2" (51 mm) clearance on each side.

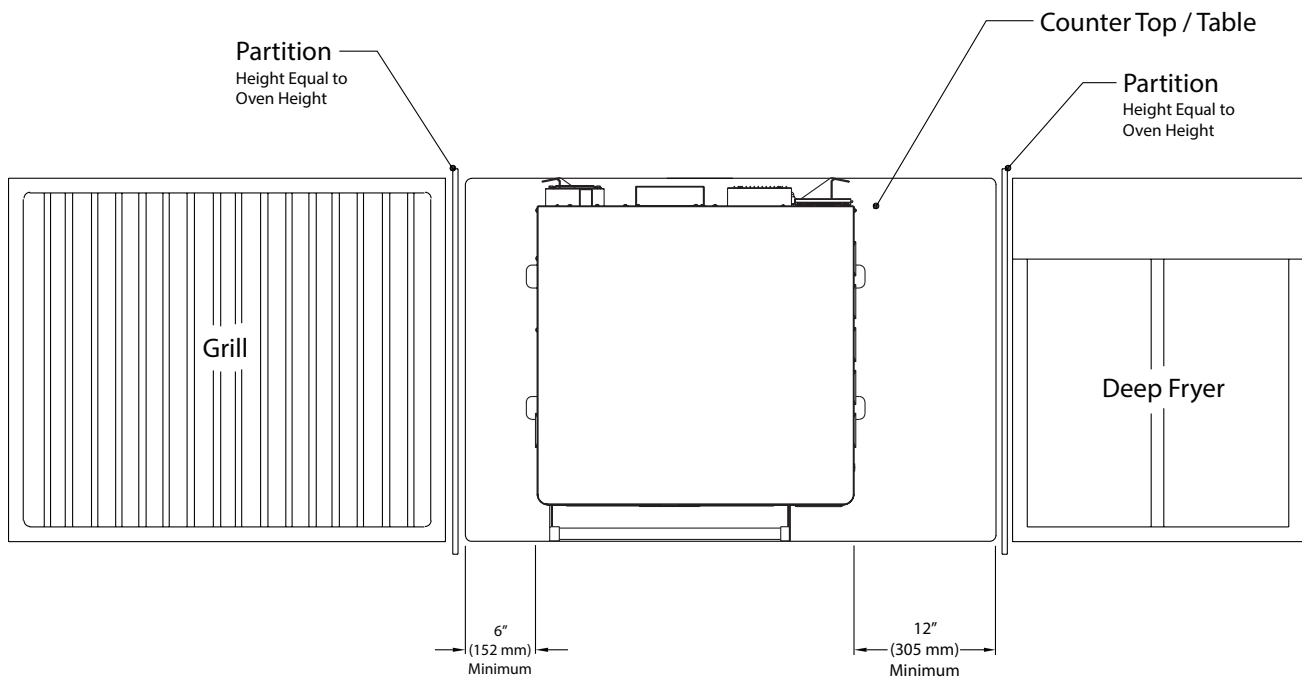



Figure 2: Installation Near Open Heat Source

Oven Restraint Kit

Part Number: TC3-0242

 **WARNING:** The Oven Restraint Kit will not prevent the oven from falling off a countertop if the oven is pulled off or allowed to slide off the edge. Installation instructions are included with the kit.

ChefComm OneTouch

Part Number: CON-7006

ChefComm OneTouch lets you easily create menu settings on a computer and upload them to an oven via USB. For more information, call TurboChef Customer Support at 800.90TURBO or +1 214.379.6000.

Open Kitchen

Open Kitchen is more than just another piece of WiFi-compatible kitchen equipment. It is a robust enterprise system for developing recipes, updating your oven settings, interpreting oven data, and much more. Open Kitchen also enables predictive servicing and maintenance of ovens. It is available for the Double Batch, Single Batch, Bullet, Eco, i1 (Sōta, Panini, Waterless Steamer), i3, and i5 ovens with Touch Controls, as well as other Middleby brand equipment.

Date and Time Prompt

The oven maintains a data log that contains valuable information about the operation of the oven, including faults, items cooked, and other events. An accurate date and time are important for the data log. If the oven loses the date and time as a result of prolonged disconnection from power, a prompt will alert the operator to set the date and time. The prompt will only occur whenever power is cycled. If bypassed, the operator must update the date and time from the Info Mode Settings screen.

Voltage Selection

For North America oven models, the oven will detect 208 or 240 incoming voltage.

Ventilation

The TurboChef Double Batch ovens have been approved by Underwriter's Laboratory® for ventless operation (UL KNLZ listing) for all food items except for foods classified as "fatty raw proteins." Such foods include bone-in, skin-on chicken, raw hamburger meat, raw bacon, raw sausage, steaks, etc. If cooking these types of foods, consult local HVAC codes and authorities to ensure compliance with ventilation requirements.

To ensure continued compliance with all health, building, and fire codes, you are required to maintain clean and sanitary conditions around your oven at all times.

NOTE: In no event shall the manufacturer assume any liability for damages or injuries resulting from installations which are not in compliance with the instructions and codes previously listed. Failure to comply with these instructions could result in the issuance of a temporary cease and desist order from the local health department until the environment concerns are addressed.

Daily Maintenance

The following steps will help maintain your oven. Use only TurboChef Oven Cleaner and Oven Guard. The use of any other cleaning products can damage critical oven components, resulting in a non-warranty service call.



Step 1



Step 2

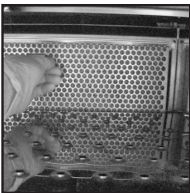

Step 3



Step 4



Step 5.1



Step 5.2

Supplies and Equipment

TurboChef® Oven Cleaner (Product Number: 10574), TurboChef® Oven Guard (Product Number: 105703), nylon scrub pad, clean damp and dry towels, disposable gloves, protective eyewear, dust mask

* The Double Batch Rapid Cook Oven includes a standard oven cleaner kit with oven guard (Product Number: 105701).

Step 1: Prepare the Oven

⚠️ WARNING: The oven operates at approximately 550°F (285°C) and may cause injury if not allowed to cool properly.

- Turn both ovens off by touching the Off icons on the top oven and bottom oven screen.
- Open the oven doors.
- DO NOT attempt to clean until both oven displays no longer reads “Cooling Down.”

Step 2: Remove and Clean the Wire Racks (Top and Bottom Oven)

⚠️ WARNING: Be sure the oven interior is cool before you remove the wire racks.

- Wash, rinse, and sanitize the wire racks.

Step 3: Remove and Clean the Grease Filters (Top and Bottom Oven)

- Lift the grease filter by the handle and pull forward.
- Wash and gently rinse the grease filters with hot water.

⚠️ WARNING: DO NOT scrub the grease filter or use a water jet when cleaning.

Step 4: Clean the Cook Chambers (Top and Bottom Oven)

- Use a food vacuum or damp towel to remove food particles from the cook chambers.
- Spray oven cleaner onto the top, bottom, and sides of the oven interiors.

⚠️ CAUTION: DO NOT spray Oven Cleaner into the holes on the back oven walls or directly onto the cook chamber lamps. Doing so can damage critical oven components, resulting in a non-warranty service call.

- For stubborn stains, spray Oven Cleaner and allow it to penetrate for 5 minutes.
- Clean the oven interiors with a nylon scrub pad.
- Wipe the cook chambers with a clean damp towel, and then a dry towel.

Step 5: Clean the Oven Doors (Top and Bottom Oven)

- Clean the metal portion of the oven doors with Oven Cleaner and a nylon scrub pad.
- Gently clean the glass windows with Oven Cleaner and a cleaning towel.

⚠️ CAUTION: DO NOT use abrasive cleaning supplies (e.g. steel wool) when cleaning the glass windows. Doing so may scratch the windows.

⚠️ CAUTION: DO NOT apply excessive force when cleaning the glass windows. Breakage will result in a non-warranty service call.

- Wipe the doors and windows with a clean, damp towel and then a dry towel.

⚠️ CAUTION: DO NOT scrub or attempt to clean the oven door gasket (Figure Step 5.2). Doing so may cause the oven doors to mis-align, resulting in a non-warranty service call.

Continued on Page 6...



Step 6

Step 6: Reinstall the Grease Filters and Wire Racks (Top and Bottom Oven)

- There are notches on the rear right and left sides of the wire rack which fit over the pins on the sides of the cook chamber. The wire rack must be installed correctly to ensure proper oven operation.

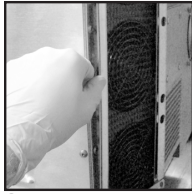

Step 7

Step 7: Clean the Air Filter

⚠ CAUTION: TurboChef does not recognize blocked air vents as a warrantable claim. The filter must be cleaned regularly or replaced if damaged. During oven operation, the filter must remain in place at all times.

- Remove the air filter from the back of the oven.
- Rinse the air filter with hot water. DO NOT scrub the filter.
- Allow the air filter to dry completely.
- Reinstall the air filter.



Step 8

⚠ CAUTION: DO NOT operate the oven without the filter in place.

Step 8: Clean the Oven Exterior

- Wipe the oven exterior with a clean, damp towel.

⚠ CAUTION: DO NOT spray chemicals into any openings, such as the louvers on the side or rear panels. Doing so can damage critical oven components, resulting in a non-warranty service call.

- Wipe the oven exterior with a clean, dry towel.

Weekly Maintenance

Once a week (or more frequently depending on use), perform the following steps to help maintain your oven. Use only TurboChef Oven Cleaner and Oven Guard. The use of any other cleaning products can damage critical oven components, resulting in a non-warranty service call.



Step 1



Step 2

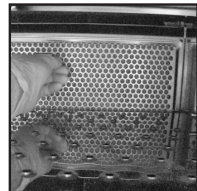

Step 3

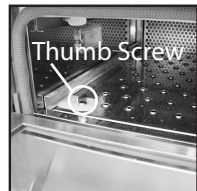

Step 4.1

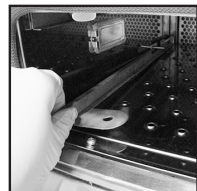

Step 4.2



Step 4.3



Step 5

Supplies and Equipment

TurboChef® Oven Cleaner (Product Number: 10574), TurboChef® Oven Guard (Product Number: 105703), nylon scrub pad, clean damp and dry towels, disposable gloves, protective eyewear, dust mask (optional).

* The Double Batch Rapid Cook Oven includes a standard oven cleaner kit with oven guard (Product Number: 105701).

Step 1: Prepare the Ovens

⚠ WARNING: The oven operates at temperatures up to 550°F (285°C) and may cause injury if not allowed to cool properly.

- Turn both ovens off by touching the Off icons on the top oven and bottom oven screen.
- Open the oven doors.
- DO NOT attempt to clean until both oven displays no longer read “Cooling Down.”

Step 2: Remove and Clean the Wire Racks (Top and Bottom Oven)

⚠ WARNING: Be sure the oven interior is cool before you remove the wire rack.

- Wash, rinse, and sanitize the wire rack.

Step 3: Remove and Clean the Grease Filters (Top and Bottom Oven)

- Lift the grease filter by the handle and pull forward.
- Wash and gently rinse the grease filters with hot water.

⚠ WARNING: DO NOT scrub the grease filter or use a water jet when cleaning.

Step 4: Remove and Clean the Bottom Jetplates (Top and Bottom Oven)

- Remove the jetplate by unscrewing the thumb screws (Figure Step 4.1) and then gently pulling the rails out and away from the oven (Figure Step 4.2).
- Remove the bottom jetplate (Figure Step 4.3).
- Wash, rinse, and sanitize the bottom jetplate.

Step 5: Clean the Cook Chambers (Top and Bottom Oven)

- Use a food vacuum or damp towel to remove food particles from the cook chambers.
- Spray oven cleaner onto the top, bottom, and sides of the oven interiors.

⚠ CAUTION: DO NOT spray Oven Cleaner into the holes on the back oven walls or directly onto the cook chamber lamps. Doing so can damage critical oven components, resulting in a non-warranty service call.

- For stubborn stains, spray Oven Cleaner and allow it to penetrate for 5 minutes.
- Clean the oven interiors with a nylon scrub pad.
- Wipe the cook chambers with a clean damp towel, and then a dry towel.

Continued on Page 8...



Step 6.1

Step 5: Clean the Oven Doors (Top and Bottom Oven)

- Clean the metal portion of the oven doors with Oven Cleaner and a nylon scrub pad.
- Gently clean the glass windows with Oven Cleaner and a cleaning towel.

⚠ CAUTION: DO NOT use abrasive cleaning supplies (e.g. steel wool) when cleaning the glass windows. Doing so may scratch the windows.



Step 6.2

⚠ CAUTION: DO NOT apply excessive force when cleaning the glass windows. Breakage will result in a non-warranty service call.

- Wipe the doors and windows with a clean, damp towel and then a dry towel.

⚠ CAUTION: DO NOT scrub or attempt to clean the oven door gasket (Figure Step 6.2). Doing so may cause the oven doors to mis-align, resulting in a non-warranty service call.



Step 6

Step 6: Reinstall the Bottom Jetplates, Grease Filters, and Wire Racks (Top and Bottom Oven)

- There are notches on the rear right and left sides of the wire rack which fit over the pins on the sides of the cook chamber. The wire rack must be installed correctly to ensure proper oven operation.

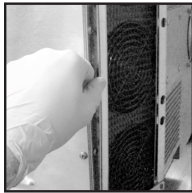

Step 7

Step 7: Clean the Air Filter

⚠ CAUTION: TurboChef does not recognize blocked air vents as a warrantable claim. The filter must be cleaned regularly or replaced if damaged. During oven operation, the filter must remain in place at all times.

- Remove the air filter from the back of the oven.
- Rinse the air filter with hot water. DO NOT scrub the filter.
- Allow the air filter to dry completely.
- Reinstall the air filter.



Step 8

⚠ CAUTION: DO NOT operate the oven without the filter in place.

Step 8: Clean the Oven Exterior

- Wipe the oven exterior with a clean, damp towel.

⚠ CAUTION: DO NOT spray chemicals into any openings, such as the louvers on the side or rear panels. Doing so can damage critical oven components, resulting in a non-warranty service call.

- Wipe the oven exterior with a clean, dry towel.

Oven Controls: OneTouch Controller

1. Power Icon

Touch to begin preheating. By default, the oven preheats to the lowest set temperature.

2. Group Select

Select a group and the oven will preheat to its set temperature. The set temperature will be displayed near the group name. If “All Recipes” is selected, the oven will preheat to the lowest recipe temperature in the menu.

3. Off Icon

Touch to turn the oven off (cool down).

4. Temperature

Temperature is displayed either on top or bottom oven screen.

5. Recipes

This is the area where the recipes are located (5).

6. WiFi Network/Network Settings

If the oven is connected via WiFi or Ethernet to Open Kitchen™, information about the connection status will be visible here.

7. Settings Icon

Touch to access Info Mode (page 13). A pass code (9 4 2 8) will be required.

8. Edit Icon

The Edit icon will only be displayed when Edit Mode (page 13) is enabled. Touching this icon will allow you to edit menu items.

9. Preheat Progress

Indicates preheat progress; touch the temperature icon (9) to view.

10. Manual Cook Mode

Use to access manual cooking (10).

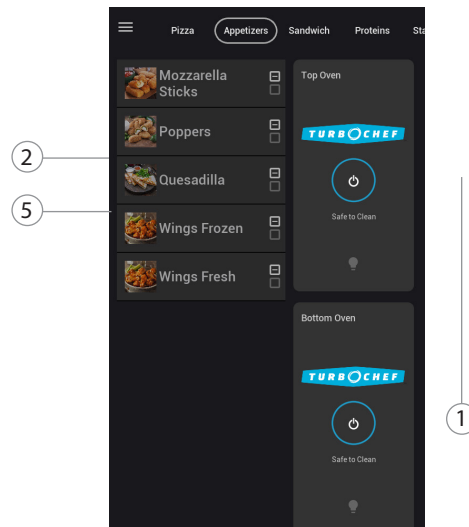

Figure 3: Oven Controls: OneTouch Power On

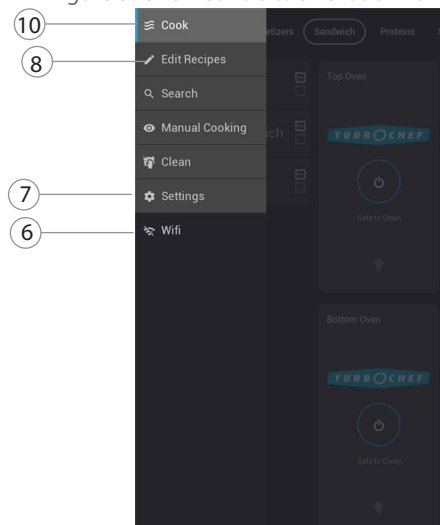

Figure 4: Oven Controls: OneTouch WiFi

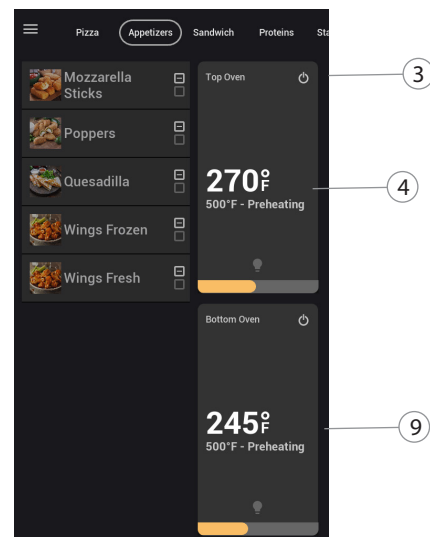

Figure 5: Oven Controls: OneTouch Preheat

NOTE: Display options vary depending on which features are enabled.

Recipe Mode: OneTouch Controller

The oven is preprogrammed with recipe settings at the time of manufacture and is ready to operate out of the box. New menu settings can be loaded via USB (page 14) or programmed manually (page 12). If settings are not present, the oven will cook only in manual mode (page 12).

This oven uses impingement and/or microwave to cook food faster than traditional cooking methods. Air enters the cavity from the top and bottom using a single fan. Because of this design and to ensure uniformity of cooking, the oven must be operated only while the bottom jetplate is in place. While the bottom jetplate is removable for cleaning, it is not removable for cooking. Without the bottom jetplate in place, the oven will not deliver the proper cooking performance to either the top or bottom of the food item. Additionally, oven damage may result.

The sequence of the steps below may vary, and some may not apply.

Step 1: Touch the Power Icon on screen to begin preheat.

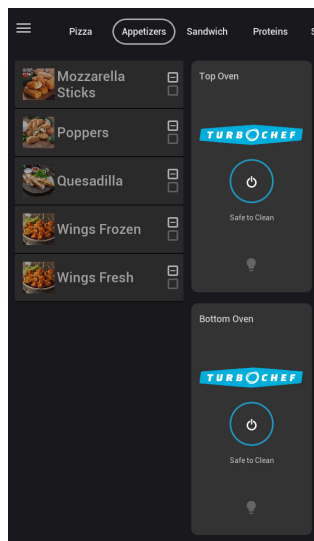

Figure 6: Power Icons

Step 2: Preheat Progress

NOTE: When the oven is done warming up, it will “soak” for an additional eight minutes. “Soaking” ensures the cavity surfaces absorb enough heat so that cooking will not be affected.

While the oven is preheating, you can touch the “Recipes” button to view recipes or select a new group.

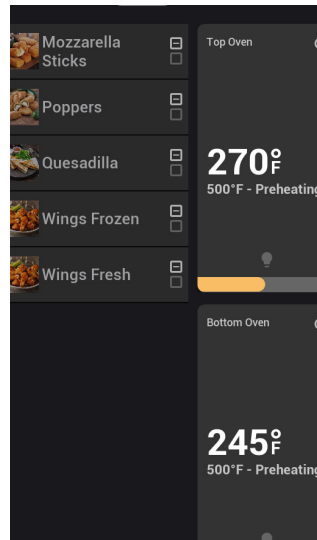

Figure 7: Preheat

Step 3: Place Food in the Oven and Select a Recipe

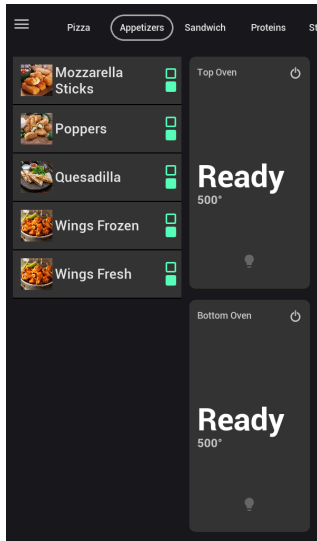

Figure 8: Recipe Selection

⚠ WARNING: Inside of oven and oven door are hot!

HHD requires the door to open to let the controller know which cavity the selected recipe will cook in the oven.

Step 4: Cooking

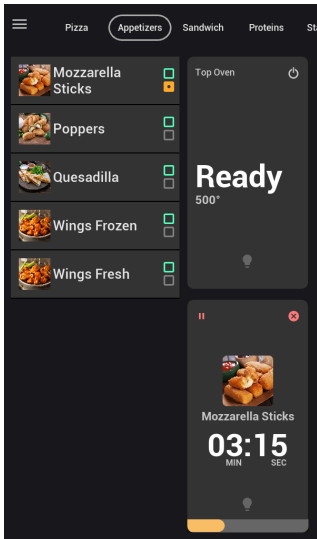

Figure 9: Cooking

Note: To immediately stop a cook cycle, touch the red “X.”

⚠ CAUTION: Opening the oven door while the cook timer is counting down could shorten the lifespan of critical oven components.

Note: If the oven door is opened during a cook cycle, the cycle will pause until the door is closed.

Step 5: Cooking Alerts

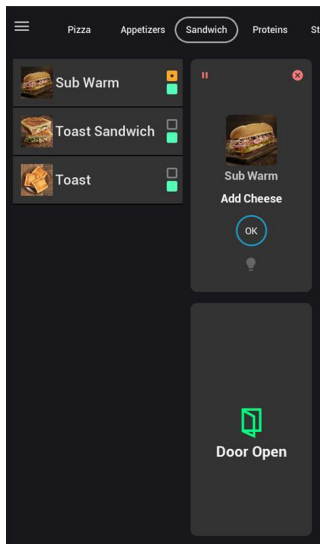

Figure 10: Mid-cook Alert

Note: Some recipes may include alerts that require action mid-cook.

Step 6: Check/Remove Food from Oven

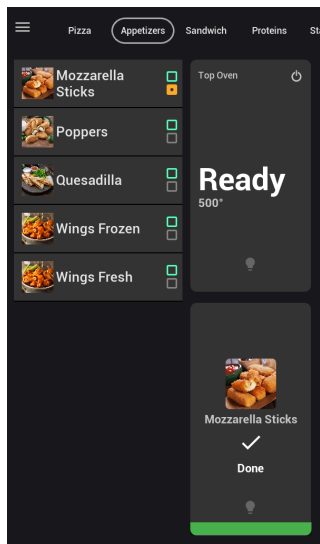
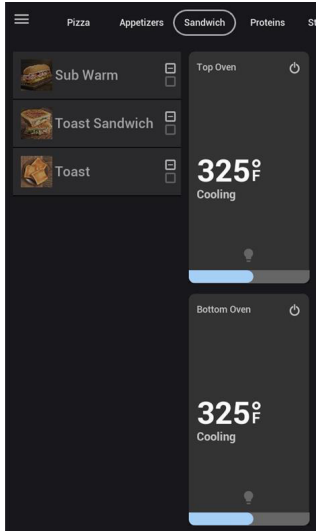

Figure 11: Check Food Timer

 **WARNING:** Dish/inside of oven and door are hot!

Note: Some recipes may include an extra timer at the end of a cook cycle. If this end-of-cycle timer expires, it means the food was left in the cavity for too long and must be discarded.

Step 7: Cooling Down



When finished cooking for the day, touch the power button (bottom left corner) to begin cooling down.

Figure 12: Off/Cooling Down

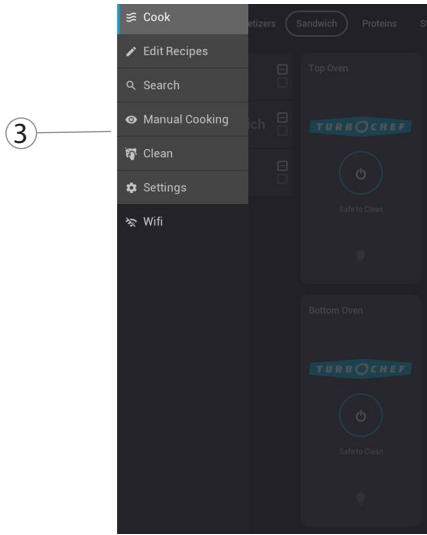

Figure 13: OneTouch Settings Menu

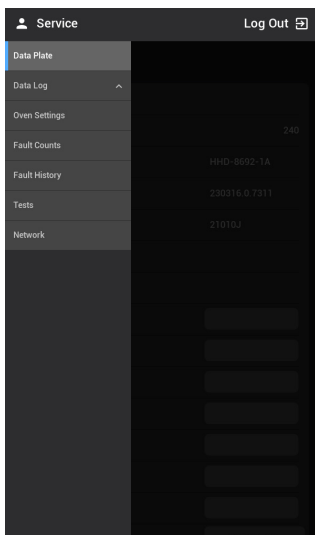

Figure 13: OneTouch Settings Menu

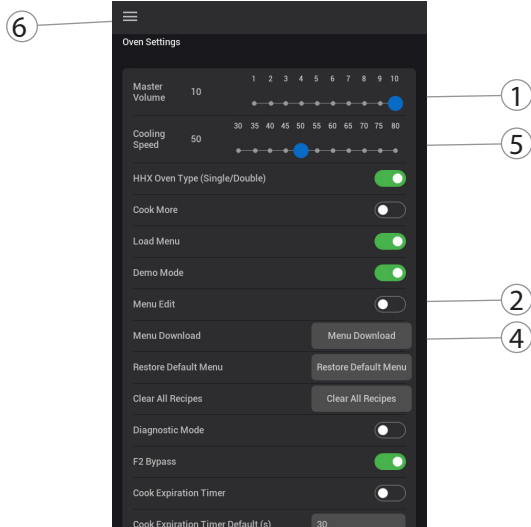

Figure 13: OneTouch Settings Menu

Settings Mode: OneTouch Controller

To access the Settings Mode, touch the Settings icon (page 9) and input the pass code 9 4 2 8.

From the Settings Mode, access:

- Data Plate
- Data Log
- Oven Settings (see below for more info)
- Fault Counts
- Fault History
- Service Settings
- Network (see below for more info)

NOTE: Additional settings will be available for technician or production test logins.

Oven Settings

1. Master Volume

Set the volume from 1-10.

2. Menu Edit

Enable or disable the button that allows the operator to edit recipe settings. See page 16 for more details.

3. Manual Cook

Enable to allow access to Manual Cooking mode. See page 12 for more details.

4. Menu Download

Downloadable from equipment onto a USB.

5. Temperature Units (C/F)

The temperature measurement setting is configured at the factory. Touch to change the temperature measurement settings.

6. Show Grid/List View Toggle

Enable or disable the button that allows the operator to change between icon/tile view and list view on the Group and Recipe screens.

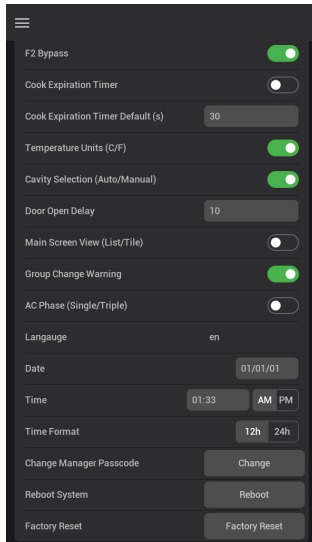

Figure 14

Search

Allows for a quick recipe search.

Demo Mode

Demo Mode is a feature used to demonstrate the cooking features of the oven without turning on the heaters or microwave system. Demo Mode must be disabled during regular operation.

F2 Bypass

The F2 alarm indicates the oven temperature is too low. F2 Bypass Enabled means the oven will not terminate a cook cycle when an F2 alarm is encountered. The oven will still log the fault condition. F2 Bypass Disabled means the oven will function as it normally would; i.e., when an F2 alarm is discovered during a cook cycle, the oven will terminate the cook cycle.

Language

The default language is English. To change to another language, touch “Language: English” and then touch the preferred language and touch “ENTER.” The available languages are:

- French
- German
- Polish
- Portuguese
- Russian
- Spanish

The available languages may also be:

- Chinese
- Korean
- Japanese

Date/Time/Time Format

The final three options allow the user to set the date, time, and time format. If the oven is connected to the internet, the date and time will synchronize with an online world clock.

Reboot

Restarts the controller/equipment.

Network

If the oven is connected to a ConnectWare module or via Ethernet, information about the connection status will be visible here. WiFi credentials (if applicable) can also be input/changed.

Load Menu from USB: OneTouch Controller

USB setup: When loading from USB, the recipe file and images/icons must be compressed into a TGZ file. If saving the menu from the oven (see below), the oven will create the TGZ file in a way that can be loaded easily to other ovens. ChefComm OneTouch also creates TGZ files for recipe updates.

TGZ menu files are not backwards-compatible for the legacy controller.

When the oven is off or cooling down, insert the USB (see below).

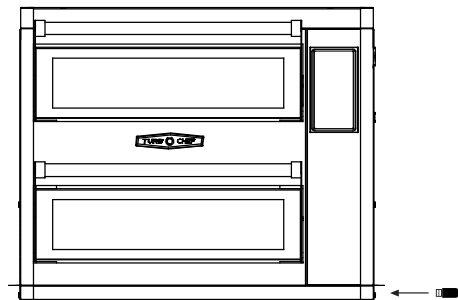

Figure 15: Insert USB

The oven will automatically detect the device. Select “Update” to proceed or “Cancel” to cancel.

The update will take several seconds, after which the controller will reboot one or two times. After the controller reboots, wait 10 seconds and then remove the USB drive.

NOTE: The process is identical for updating oven firmware. Do not update firmware unless instructed by the factory.

Save Menu to USB: OneTouch Controller

When the oven is off or cooling down, insert the USB (see previous section).

Select “Save to USB.”

Creating a Group

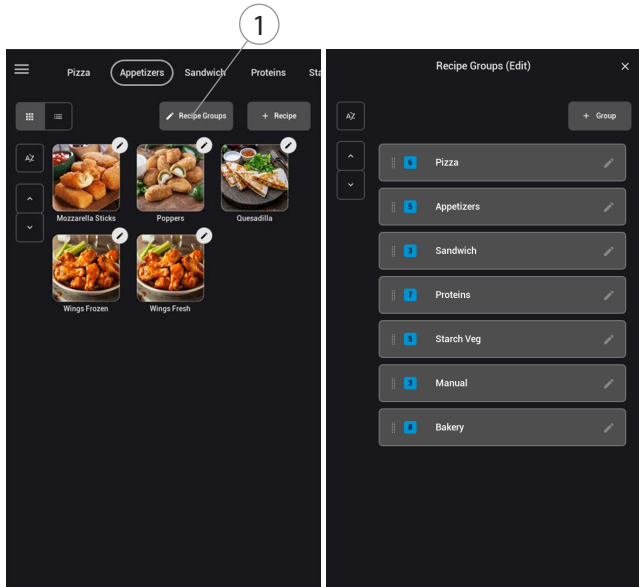

Figure 16: Edit Screen

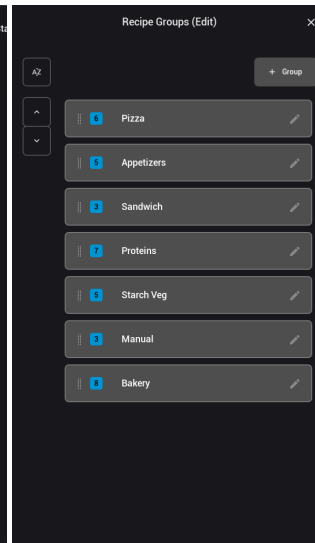

Figure 17: Edit Mode: Group Edit

NOTE: At any time, touch the “X” in the top-right corner to cancel the action of creating a group.

From the group select screen:

1. Touch the Recipes Groups edit button (1) in the top-right corner of the screen (Figure 16, above).
If the edit button is not present, verify it is enabled in the Settings menu (see page 13).
2. Touch the “+Group” button (Figure 17 above).
3. Input the group name and touch the blue arrow button to continue (Figure 18, below).

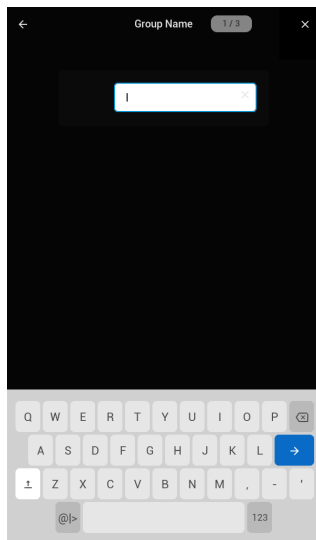

Figure 18: Name New Group

4. Add recipes (or subgroups) to the group by selecting/deselecting each recipe, and click the blue “Next” button.

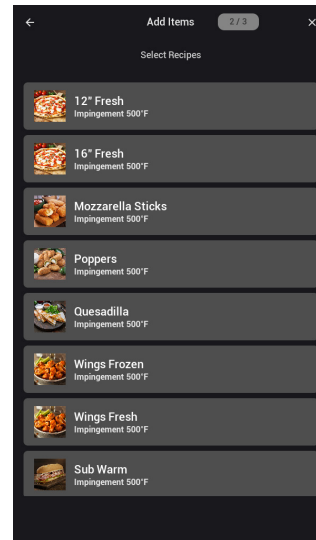

Figure 19: Select Group Image

NOTE: The set temperature of the first recipe determines the temperature for the group. If some recipes were developed at a different set temperature, they will not be selectable after the first recipe is selected.

Editing a Group

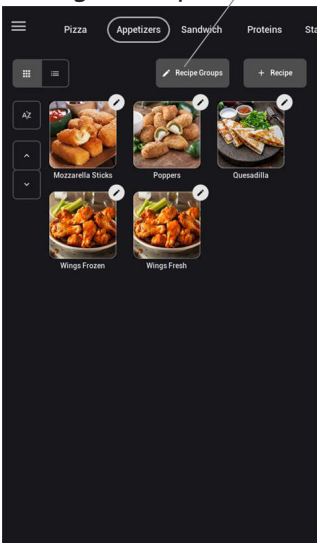

Figure 20: Edit Screen

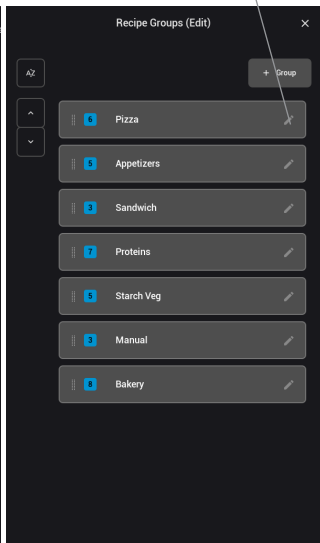

Figure 21: Edit Mode: Group Edit

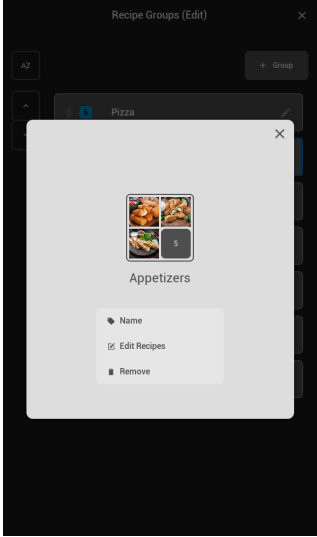

Figure 22: Edit Group Options

NOTE: At any time, touch the “X” in the top-right corner to cancel the action of editing a group.

From the group select screen:

- 1. Select an option (Figure 22).

NOTE: See section “Editing a Recipe” for more information about the “Edit Recipe” option.

NOTE: At any time, touch the “X” in the top-right corner to cancel the action of creating a group.

From the group select screen:

- 1. Touch the Recipes Groups edit button (1) in the top-right corner of the screen (Figure 20, above).
If the edit button is not present, verify it is enabled in the Settings menu (see page 13).
- 2. Touch the “edit” button (2) (Figure 21 above).

Creating a Recipe

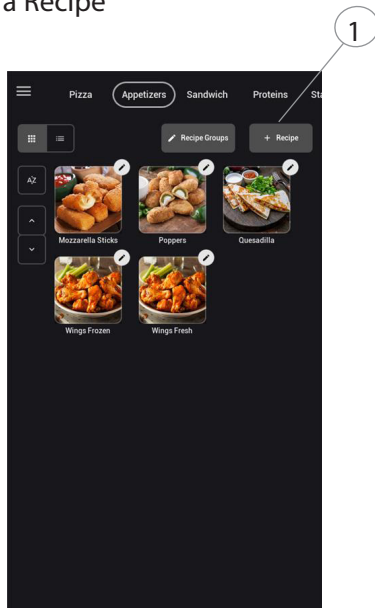

Figure 23: Edit Screen

NOTE: At any time, touch the “X” in the top-right corner to cancel the action of creating a recipe.

From the group select screen:

1. Touch the +recipe edit button (1) in the top-right corner of the screen (Figure 23, above).

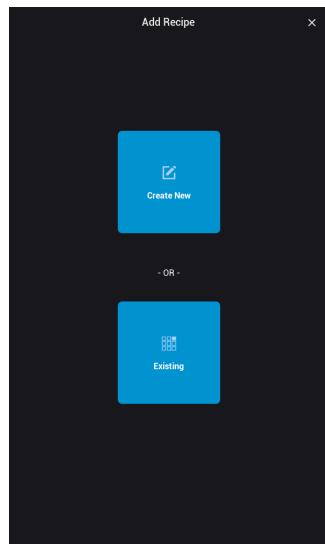

Figure 24: Add/Create Recipe

2. Touch the “create new” recipe button shown above. (Figure 24).

3. Input the recipe name and touch the blue arrow button to continue (Figure 25, below).

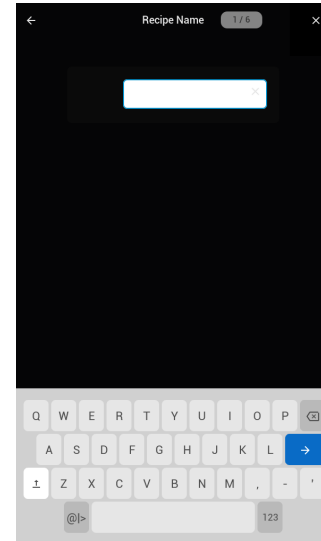

Figure 25: New Recipe Name

4. Input keywords for the search option and touch the blue arrow button to continue (Figure 26).

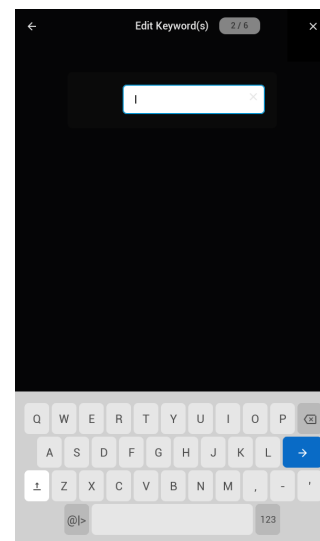

Figure 26: New Recipe Keywords

5. Select an image and touch the blue “Next” button (Figure 27, below).

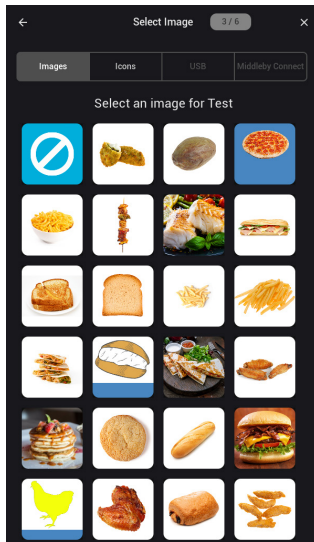

Figure 27: Select Image for New Recipe

NOTE: If you have a USB drive with image files inside a folder named “Images,” insert it from this screen and select “USB” to assign the image.

6. Input the recipe temperature and touch the blue arrow button to continue.

NOTE: This option will only appear if you opted to create a recipe from the “All Recipes” screen. Otherwise, the recipe temperature will be applied from the group from which “+Recipe” was selected.

7. Add cook settings:

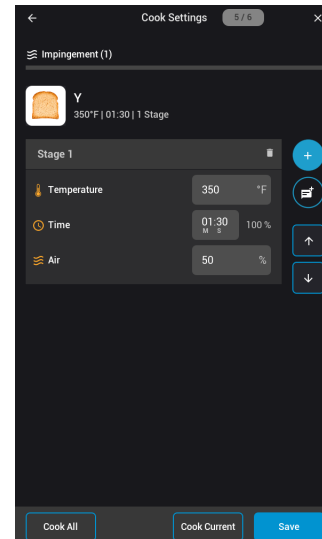

Figure 28: New Recipe Cook Settings

- a. Touch the “+” button to add a stage.
- b. Touch the stage to reorder it or to edit cook settings including:
 - Cook time per stage
 - Percent air per stage
 - Percent microwave per stage
- c. Touch the trash can to delete a stage.
- d. Touch the note bubble to add a cooking note that will appear in the cook cycle between stages. See step 6 on page 11 for more details.
- e. Touch the left or right arrows to rearrange stages.
- f. Touch “Cook” to perform a test cook.
- g. Touch “Save” to continue.
- h. Touch the back arrow to return to the previous step.

11. Select which group(s) to which the recipe will be added (Figure 29, below).

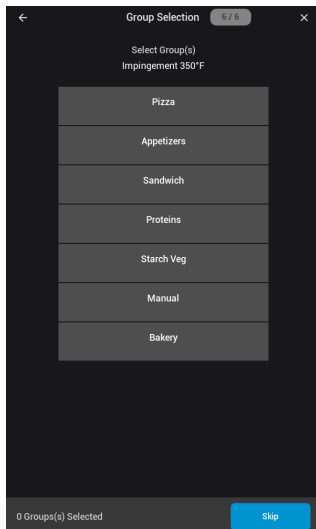

Figure 29: Select Groups to Place Recipe Into

12. Touch “Next” (or “Skip” if no groups are selected).

Adding a Recipe to a Group

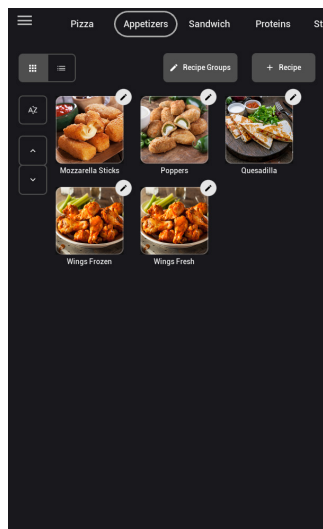

Figure 31: Select Groups to Place Recipe Into

6. Touch “Next”.

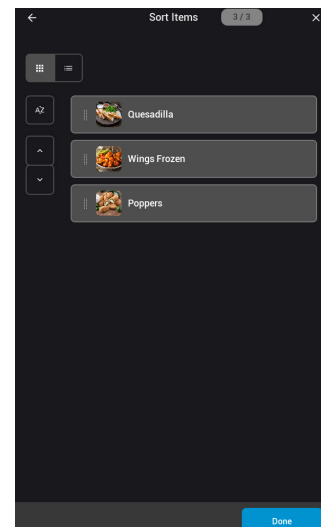

Figure 32: Sort Recipes in Group

NOTE: At any time, touch the “X” in the top-right corner to cancel the action of adding a recipe.

From the group select screen:

1. Select a group for which you want to add or create a recipe.

NOTE: To create a recipe without selecting a group, select the “all recipes” button.

2. Touch the Edit button in the top-right corner of the screen.

If the edit button is not present, verify it is enabled in the Settings menu (see page 11).

3. Touch the “+Recipe” button (Figure 30, above).
4. Select “Existing”.
5. Select a recipe (or recipes) to add to the group (Figure 31, below).

NOTE: Only recipes with set temperatures that match the group set temperature will be selectable.

7. Sort recipes in the group by holding/dragging items in place. You can also sort in alphabetical order using the “A/Z” button.

8. Touch “Save”.

Editing a Recipe

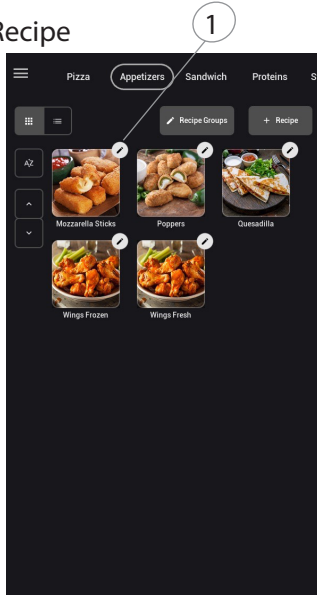

Figure 33: Select Recipe to Edit

NOTE: At any time, touch the “X” in the top-right corner to cancel the action of editing a recipe.

From the group select screen:

1. Select a group that contains the recipe you want to edit.

NOTE: To edit a recipe without selecting a group, select the “all recipes” button.

2. Touch the Edit button (1) next to a recipe.

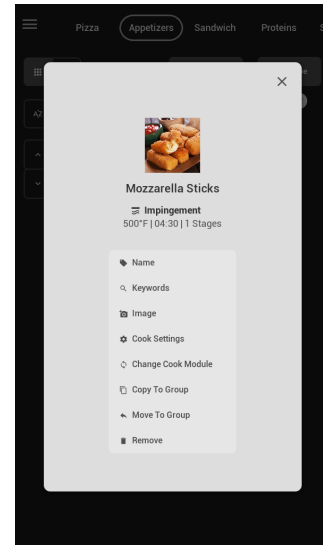

Figure 34: Edit Recipe Options

3. Select an option (Figure 34, above).

- Edit the recipe name and/or keywords for the search option.

- Change the recipe image/icon.

- Edit the recipe temperature.

NOTE: Editing the temperature will cause the recipe to become disassociated from groups it is currently in.

- Edit the recipe offset temperature.

- Edit the cook settings (see step 10, page 17 for more information).

- Copy the recipe to a new group or groups.

- Move the recipe to a new group or groups.

- Remove/delete the recipe.

Instructions for Recipe Cooking at Different Temperatures

The following instructions are for setting up recipes on the TurboChef Double Batch One Touch Ovens. The HHD can be set to cook multiple recipes at the same temperature set point in both ovens or cook recipes at different temperature set points per oven.

Example #1: Creating and Assigning Recipes to Specific Top, Bottom or all Ovens:

Recipe: Poppers is created to cook at 350 degree F and set to top oven cooking. Follow below steps to create this recipe –

- o Press the information button () on the top left corner.
- o Select “Edit Recipes”.
- o Enter the login “9428”.
- o Select + Recipe
- o Select Create New
- o Enter Recipe Name “Poppers” and hit next arrow to proceed.
- o User choice to Add Key words, this is optional. It can be left blank as well. Select arrow to proceed.
- o Select an image, hit next at the bottom of the screen.
- o Select Top Oven
- o Enter Temp of 350 F, desired time, and air %
- o Press Save
- o On the next screen for group, press Skip for the group selection as that will be done later.
- o Don’t exit recipe creation screen and follow instructions below.

Recipe: Quesadilla is created to cook at 350 deg F and set to Both oven cooking. Follow below steps to create this recipe.

- o Select + Recipe
- o Select Create New
- o Enter Recipe Name “Quesadilla” and hit next arrow to proceed.
- o User choice to Add Key words, this is optional. It can be left blank as well. Select arrow to proceed.
- o Select an image, hit next at the bottom of the screen.
- o Select All Ovens
- o Enter Temp of 350 F, desired time, and air %
- o Press Save
- o On the next screen for group, press Skip for the group selection as that will be done later.
- o Don’t exit recipe creation screen and follow instructions below.

Recipe: Mozzarella Sticks is created to cook at 500 deg F and set for Bottom oven cooking. Follow below steps to create this recipe.

- o Select + Recipe
- o Select Create New
- o Enter Recipe Name “Mozzarella Sticks” and hit next arrow to proceed.
- o Choice to Add Key words and/or hit arrow to proceed.
- o Select an image, hit next at the bottom of the screen.
- o Select Bottom Oven
- o Enter Temp of 500 F, desired time, and air %
- o Press Save
- o On the next screen for group, press Skip for the group selection as that will be done later.

A group “Food is created” with the above three recipes by following the steps below –

- o Select Edit Group
- o Select + Group
- o Name Group as Food, select to proceed.
- o On Select Recipe screen – first select Poppers as the Primary Recipe, then Quesadilla and at last select Mozzarella Sticks.

It is important to select Poppers first, which cooks at 350 F (lower than 500 F) as the primary recipe in the group Food.

- o Select Next, you should see the 3 recipes in the group.
- o Select Done.
- o Exit the Edit Group Screen by pressing the x on the top right corner of the screen.
- o Now select the information button () on the top left corner.
- o Select Cook
- o Select the Group “Food” from the top.
- o Wait for both ovens to reach the primary recipe set-point temperature – in this case it will be 350 F.
- o The following picture 1 shows the 3 recipes, Poppers set for top oven at 350 F, Quesadilla set for All ovens at 350 F, and Mozzarella Sticks set for bottom oven at 500.

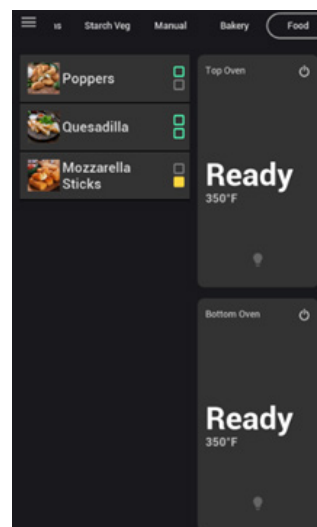

Picture 1

Green outline on recipes Poppers and Quesadilla indicates the ovens in which the recipe can be cooked right away. Poppers in the top and Quesadilla in both.

Opening the specific oven door turns the green outline box to a solid green, indicating the recipe button can be pressed and the cook initiated in the selected oven.

The yellow button next to Mozzarella Sticks indicates that it can be cooked in the bottom oven however the yellow indicates it's not ready yet because of the different temperature set point.

To set the bottom oven for cooking at the 500 F set point, press the yellow button Mozzarella Sticks recipe. This will prompt the following message, Picture 2, Select Set New Temp.

See next page.

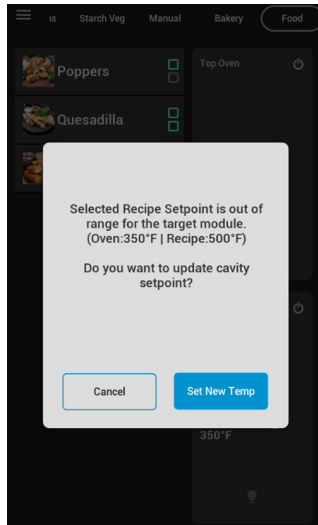

Picture 2

The bottom oven will begin to seek Mozzarella Sticks 500 F set point, shown in Picture 3.

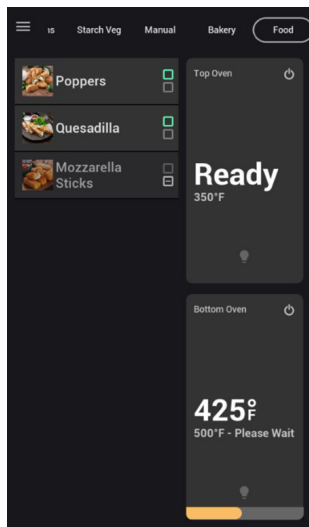

Picture 3

When the bottom oven reaches its 500 F set point, all the three recipes will be ready to cook. See Picture 4. Poppers and Quesadilla in the top oven at 350 F and Mozzarella Stick in the bottom oven at 500 F.

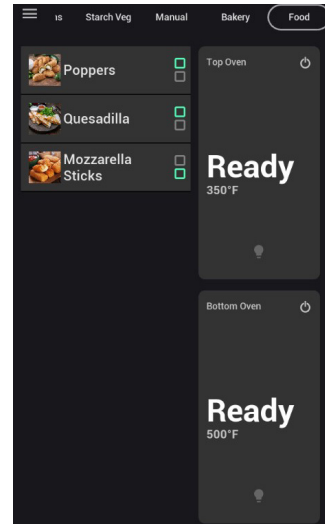

Picture 4

Example #2: Assigning recipes to “All” Ovens and operating at two different temperatures.

Recipe: Quesadilla is created to cook at 350 F and set to All oven cooking. Follow below steps to create this recipe –

- o Press the information button () on the top left corner.
- o Select “Edit Recipes”.
- o Enter the login “9428”.
- o Select + Recipe
- o Select Create New
- o Enter Recipe Name “Quesadilla” and hit next arrow to proceed.
- o User choice to Add Key words, this is optional. It can be left blank as well. Select arrow to proceed.
- o Select an image, hit next at the bottom of the screen.
- o Select All Ovens
- o Enter Temp of 350 F, desired time, and air %
- o Press Save
- o On the next screen for group, press Skip for the group selection as that will be done later.
- o Don’t exit recipe creation screen and follow instructions below.

Recipe: Mozzarella Sticks is created to cook at 500 F and set for All oven cooking.

- o Select + Recipe
- o Select Create New
- o Enter Recipe Name “Mozzarella Sticks” and hit next arrow to proceed.
- o User choice to Add Key words, this is optional. It can be left blank as well. Select arrow to proceed.
- o Select an image, hit next at the bottom of the screen.
- o Select All Oven
- o Enter Temp of 500 F, desired time, and air %
- o Press Save
- o On the next screen for group, press Skip for the group selection as that will be done later.

A group “Food is created” with the above two recipes by following the steps below –

- o Select Edit Group
- o Select + Group
- o Name Group as Food, select arrow to proceed.
- o On Select Recipe screen – first select Quesadilla as the Primary Recipe and then Mozzarella Sticks. It is important to select Quesadilla first, which cooks at 350 F (lower than 500 F) as the primary recipe in the group Food.
- o Select Next, you should see the 2 recipes in the group.
- o Select Done.
- o Exit the Edit Group Screen by pressing the x on the top right corner of the screen
- o Now select the information button () on the top left corner.
- o Select Cook
- o Select the Group “Food” from the top
- o A group “Food” is created with the above two recipes. As noted earlier, Quesadilla which cooks at 350 F (lower than 500 F) should be the first recipe to be selected in the group Food.

- o After creating the recipes and group, power both the ovens ON.
- o Wait for both ovens to reach the primary set-point temperature – in this case it will be 350 F.
- o The following picture 5 shows the 2 recipes, Quesadilla set for both ovens at 350 F, the green outline indicating that its ready to cook in both ovens.
- o The Mozzarella Sticks default to the bottom oven with the solid yellow indicator, to be cooked at 500 F.

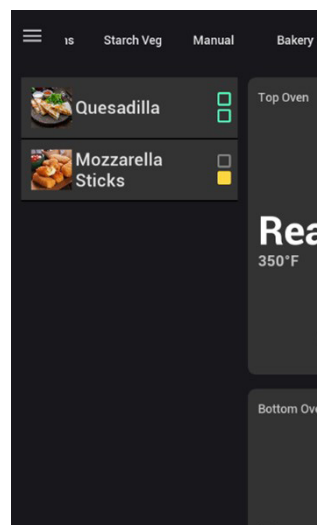

Picture 5

Option A – Cooking Quesadilla at 350 F in the top oven and Mozzarella Sticks at 500 F in the bottom oven

- o If we want the bottom oven at 500 F, simply press on Mozzarella Sticks. A confirmation box will appear as shown in Picture 6.

See next page.

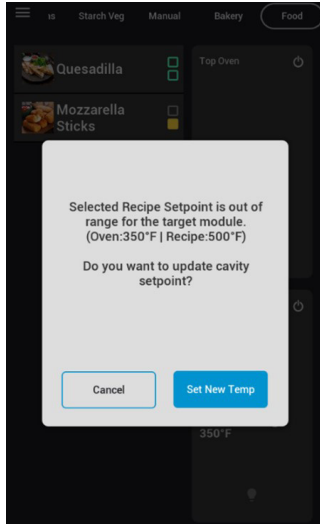

Picture 6

Once confirmed, the bottom oven will heat to 500 F and the final screen will be as shown in Picture 7. So Top Oven at 350 F and Bottom Oven at 500 F.

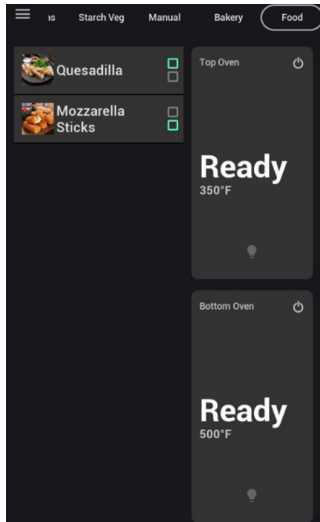

Picture 7

Option B – Cooking Quesadilla at 350 F in the bottom oven and Mozzarella Sticks at 500 F in the top oven.

- o If you want the top oven to be 500 F and the bottom oven at 350 F, then do the following:
- o Begin cooking on the bottom oven by opening the bottom door and selecting your 350 F recipe as shown below in Picture 8.
- o Notice Mozzarella Sticks changing yellow box from bottom oven to top.

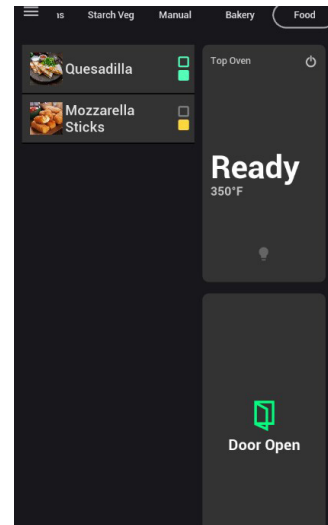

Picture 8

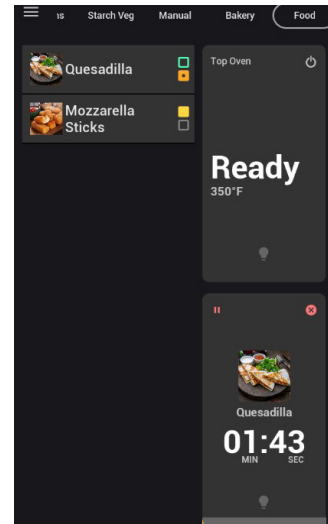

Picture 8

Now press the Mozzarella sticks menu - it will ask to change the temperature on the top Oven now as seen in the Picture 9 below.

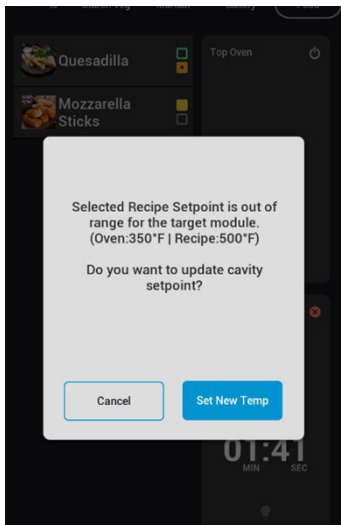

Picture 9

Pressing "Set New Temp" will now change the top bay to be 500 F, Picture 10. So bottom oven at 350 F and Top oven at 500 F.

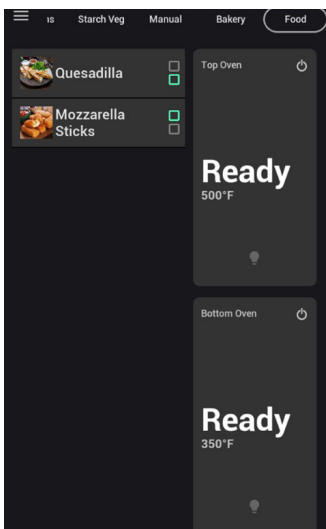

Picture 10

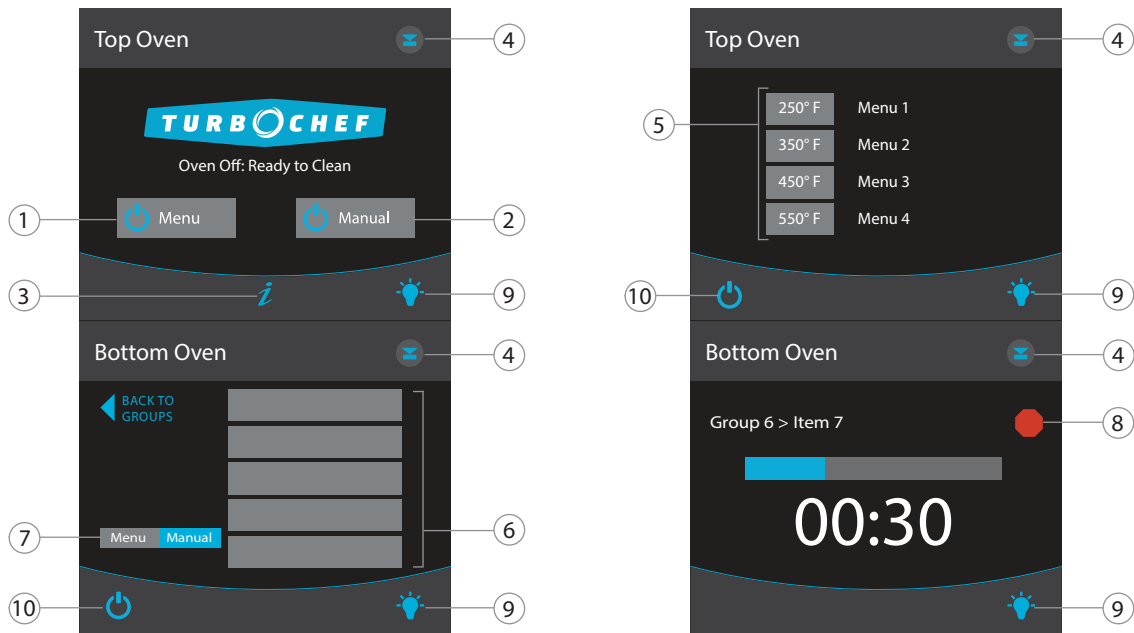

NOTE: Display options vary depending on which features are enabled.

Oven Controls: Legacy Controller

The Double Batch's interface allows simultaneous control over both ovens. During standard operation, the top oven is controlled by the upper half of the screen and the bottom oven is controlled by the lower half. The user can expand the upper/lower interface to access more options when needed. When one oven interface is expanded, the other oven interface will be limited.

1. Menu Icon/Temperature Icon

Touch to turn the oven on and cook in Menu Cook Mode (page 21).

2. Manual Icon

Touch to turn the oven on and cook in Manual Cook Mode (page 21). The Manual icon is only present if enabled from the options screen (page 23).

3. "i" Icon

Touch to access Info Mode. The "i" icon is only displayed when the ovens are off or cooling down.

4. Expand/Collapse Icon

Touch to expand or collapse the controls for the top/bottom oven.

5. Menu Selection

The oven contains 8 menus. The top oven contains menus 1-4 and the bottom oven contains menus 5-8.

NOTE: Some models may not include multi-temperature/menu selection.

6. Groups/Items

Each menu contains 10 groups. Groups 1-5 are available from the standard operation screens. Expand the oven controls to access groups 6-10. Each food group contains 10 items divided into 2 groups of 5, the first 5 items are available from standard operation, expand the screen to access items 6-10.

7. Menu/Manual Toggle

The Menu/Manual toggle will only be displayed when manual cooking is enabled and will allow you to switch between Menu Mode (page 21) and Manual Mode (page 23).

8. Stop Icon

Touch to immediately terminate a cook cycle.

9. Light Icon

Touch to turn the oven light on and off for the top/bottom oven.

10. Off Icon

Touch to turn the oven off (cool down).

Menu Cook Mode: Legacy Controller

The oven is preprogrammed with recipe settings at the time of manufacture and is ready to operate out of the box. New menu settings can be loaded via USB or programmed manually. If settings are not present, the oven will cook only in manual mode (page 23).

The Double Batch oven uses impingement to create high heat transfer rates and reduce cook time. Air enters the cavity from the top and bottom and is distributed by the jetplates. Because of this design and to ensure uniformity of cooking, the top and bottom jetplates must be installed during operation.

The sequence of the steps below may vary, and some may not apply.

Step 1: Touch “Menu” Icon to Turn the Oven On and Select a Temperature

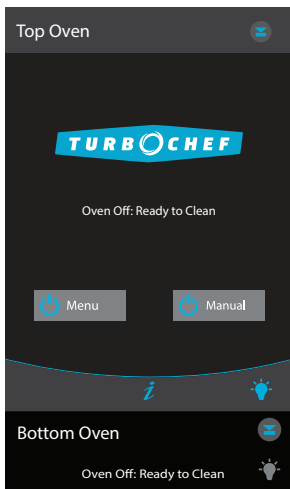

Step 2: Select a Menu

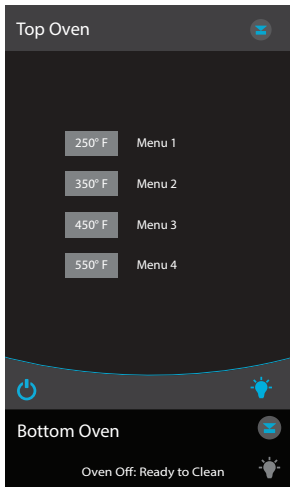

NOTE: Some models may not include multitemperature/menu selection.

Step 3: Warming Up

NOTE: When the oven is done warming up, it will “soak” for an additional eight minutes. “Soaking” ensures the cavity surfaces absorb enough heat so that cooking will not be affected.

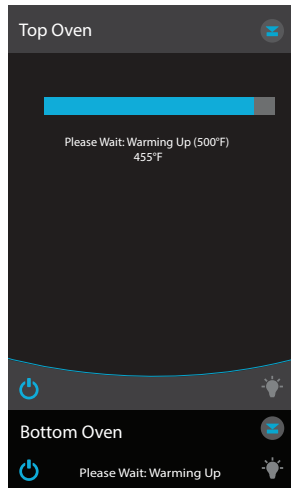

Step 4: Place Food in the Oven

⚠ WARNING: Inside of ovens and oven doors are hot!

Step 5: Select a Group



NOTE: Touch the Expand/Collapse icon to access additional groups.

Step 8: Check/Remove Food from Oven

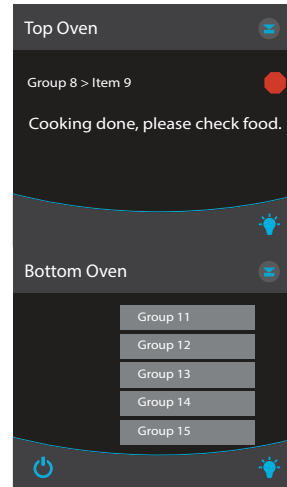

⚠ WARNING: Dish/inside of oven and door is hot!

Step 6: Select an Item

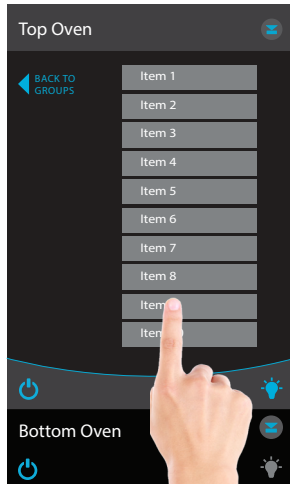

NOTE: Touch the Expand/Collapse icon to access additional items.

Step 9: Cook More

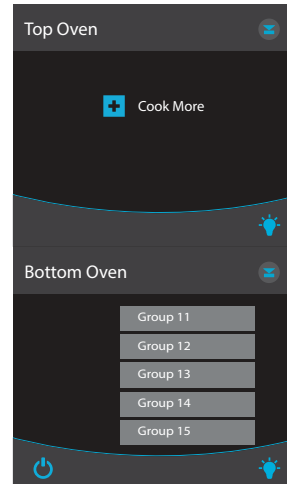

NOTE: This option must be enabled from the Options Screen (page 25) in order to cook an item beyond its original cook time.

Touch “Cook More” to cook the item for 20% longer with 100% air.

Step 7: Cooking

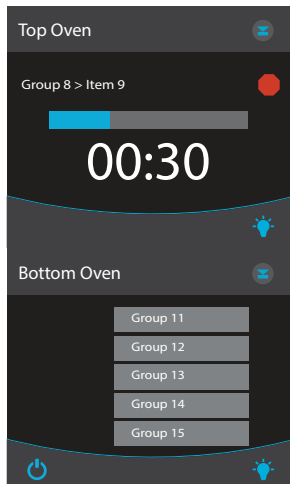

NOTE: To immediately terminate a cook cycle, touch the red “STOP” icon.

Note: If the oven door is opened during a cook cycle, the cycle will pause until the door is closed.

Step 10: Cooling Down

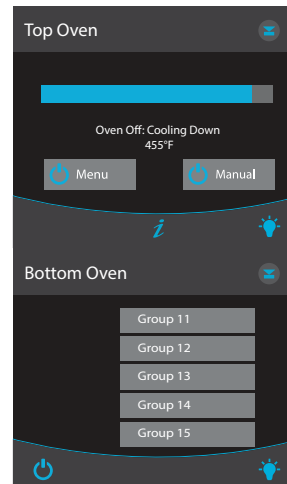

When finished cooking for the day, touch “OFF” to begin cooling down.

Manual Cook Mode: Legacy Controller

Manual Cook Mode is intended for professionals, and allows cooking “on the fly,” whereas Menu Cook Mode (page 21) allows cooking from preset cook settings. Some oven versions also allow holding temperatures. To access Manual Cook Mode, touch the Manual icon when the oven is off or cooling down (page 22) or touch the Menu/Manual toggle on the Menu Mode screen. Manual Cooking can be enabled and disabled from the Options Screen (page 25).

To cook or hold an item in Manual Cook Mode, adjust the settings using the icons on the screen, allow the oven to warm or cool to the set temperature, and touch the cook icon.

1. % Air

% Air determines the amount of airflow. The more air, the more the product will brown or crisp. % Air can be set from 10-100% or 0-100% via four icons:

- Reset the air to 10% or 0%
- Add 5%
- Add 10%
- Add 25%

2. Cook Time

Time can be set from 00:05-99:55 (mm:ss). There are four time icons.

- Clear (or “zero”) the time
- Add 5 seconds
- Add 30 seconds
- Add 60 seconds

3. Set Temperature

Touch to change the set temperature. The temperature range is 300–550°F in 25°F increments (150–285°C in 10-15°C increments) or 150-550°F in 10°F increments (65–285°C in 5-10°C increments).

4. Cook

Touch to cook (not necessary if holding).

NOTE: The oven may require additional warming time.

5. Off Icon

Touch to turn the oven off (cool down).

6. Menu/Manual Toggle

Switch between Menu Cook Mode (page 21) and Manual Cook Mode.

7. Expand/Collapse Icon

Touch to expand or collapse the controls for the top/bottom oven.

8. Light Icon

Touch to turn the oven light on and off for the top/bottom oven.

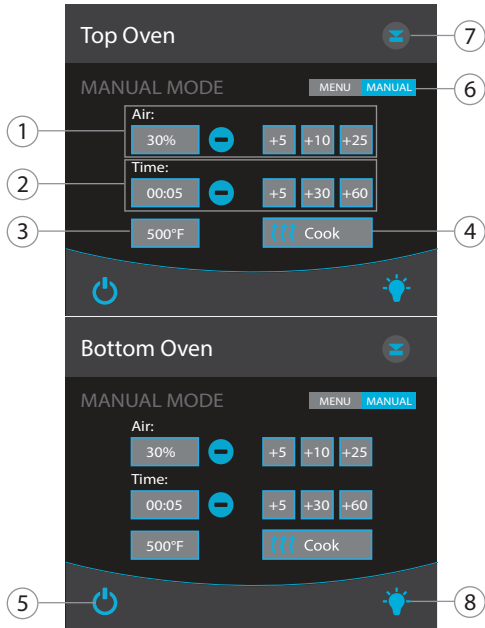

Figure 36: Manual Cook Mode

Info Mode: Legacy Controller

To access Info Mode, touch the “i” icon when the ovens are off or cooling down. From the Info Mode screen (Figure 37), access:

- Information screen
- Counters screen
- Options screen
- Settings screen
- Service mode
- MFG mode

To access each screen, touch the corresponding icon (e.g. touch “COUNTERS” to access the Counters screen).

The Options, Settings, Service, and MFG screens require a passcode to access. Touch “Login” and, when prompted, input the password 9 4 2 8 and touch the check icon in the bottom-right corner of the screen (Figure 38).

Information Screen

From the Information screen (Figure 39), view:

- Serial Number
- Menu Version
- Sage Firmware Version
- Phoenix Firmware Version
- Service Number
- Language
- VAC (Voltage) - View Incoming

Counters Screen

From the Counters screen (Figure 40), view:

- Cook Counter
- Total Cook Time in cumulative hours
- Total Time (oven on) in cumulative hours
- Power Cycles: The number of times the oven has cycled power.
- Erase Counters (option available while logged in)
- Fault Log

Counters Screen - Fault Log

The fault log is split into the “Count” screen and the “History” screen.

Count Screen: Displays the number of times a fault has occurred (Figure 41).

History Screen: Displays the timestamp of each fault occurrence (Figure 42).

Touch the “COUNT” / “HISTORY” toggle on the left-side of the screen to switch between these screens.

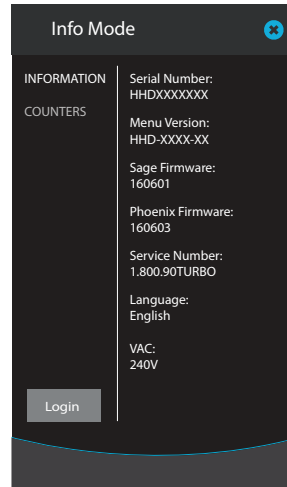

Figure 37: Info Mode

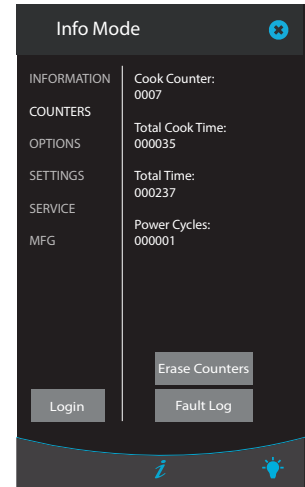

Figure 40: Counters Screen

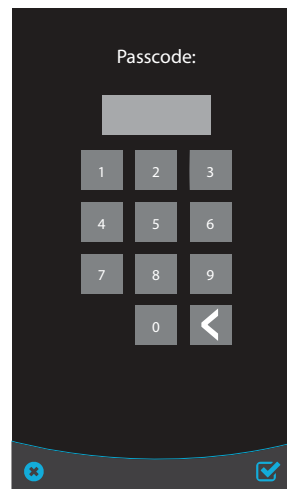

Figure 38: Passcode Screen

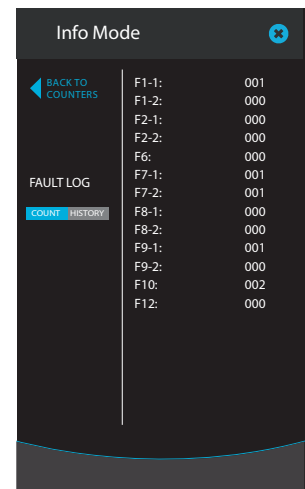

Figure 41: Fault Log - Count

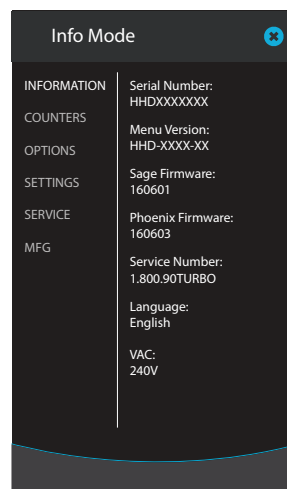

Figure 39: Information Screen

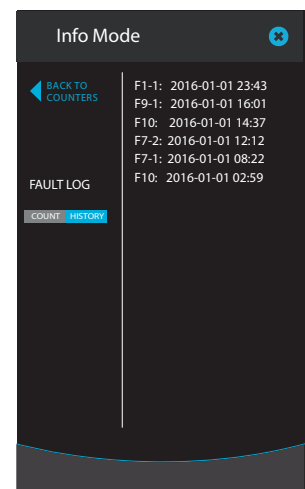

Figure 42: Fault Log - History

Options Screen

From the options screen (Figure 43), enable/disable:

- Editing
- Cook More
- Load Menu
- VAC
- Demo Mode
- Manual Cooking
- Diagnostic Mode
- F2 Bypass

You must enter the passcode 9 4 2 8 to access this screen; see page 24 for more details.

Options Screen - Editing

This toggle changes the oven between standard Menu Mode and Edit Mode. For more information on Edit Mode, see page 27.

Options Screen - Cook More

Cook More controls whether or not the “Cook More” option appears when a cook cycle is done. This option must be enabled in order to cook an item beyond its original cook time. See page 22 for details.

Options Screen - Load Menu

Load Menu enables or disables the “load menu” option on the USB detection screen. See page 29 for more details.

Options Screen - VAC

When VAC is set to YES the incoming voltage will be displayed on the Info screen. This is set by the factory and should not be changed.

Options Screen - Demo Mode

Demo Mode is a feature used to demonstrate the cooking features of the oven without turning on the heaters. Demo Mode must be set to NO during regular operation.

Options Screen - Manual Cooking

When Manual Cooking is set to YES, the operator can cook items “on the fly.” See page 23 for more details.

Options Screen - Diagnostic Mode

Diagnostic Mode allows service technicians to view and test oven components. Diagnostic Mode should be set to NO during regular operation.

Options Screen - F2 Bypass

If F2 Bypass is set to YES, the oven will log an F2 fault condition should one occur, but it will not terminate a cook cycle. If F2 bypass is set to NO, then the oven will terminate a cook cycle upon discovery of an F2 fault condition.

Settings Screen

From the Settings screen (Figure 47), set:

- Temperature
- Language
- WiFi Network
- Volume
- Date
- Time

You must enter the passcode 9 4 2 8 to access this screen; see page 24 for more details.

Settings Screen - Temperature Measurement

The temperature measurement setting is configured at the factory. Touch the toggle to change between °F (Fahrenheit) and °C (Celsius).

Settings Screen - Language

The default language is English. To change to another language, touch “Language: English” and then touch the preferred language and touch “ENTER.”



Figure 43: Options Screen

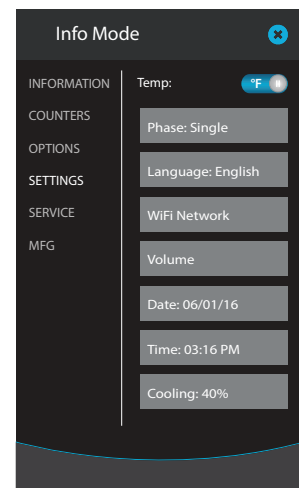

Figure 44: Settings Screen

Settings Screen - WiFi Network

Connecting the oven to a WiFi network and utilizing TurboChef's connectivity service (TurboChef Connect) allows you to remotely update the menu for one or all of your ovens and enables access to reporting tools and live data streams to view what is being cooked and when. TurboChef Connect also allows you to receive alerts via email.

Special instructions for corporate/chain customers may be required. Contact your facility administrator for more information.

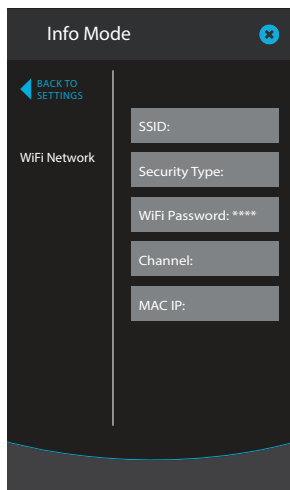

Figure 45: WiFi Screen

SSID

The SSID is the case-sensitive name of the WiFi network that the oven will join. After touching the SSID icon, use the on-screen keyboard to type in the WiFi network name and touch the check icon in the bottom-right corner of the screen.

If you are unsure of the SSID for the network, contact your network administrator. In some instances, the SSID may be printed on a label on the bottom of your WiFi router.

Security Type

The Security Type is set by your WiFi router. After touching "Security Type," select the security type being used by your router: Open, WPA, WPA2, WEP.

After selecting the correct Security Type, touch the check icon in the bottom-right corner of the screen.

If you are unsure of the Security Type being used by the network, contact your network administrator. In some instances, the Security Type may be printed on a label on the bottom of your WiFi router.

WiFi Password

The WiFi Password is the case sensitive password needed to join the WiFi network. After touching the WiFi Password icon, use the on-screen keyboard to type in the WiFi network password and touch the check icon in the bottom-right corner of the screen.

If you are unsure of the WiFi Password for the network, contact your network administrator. In some instances, the WiFi Password may be printed on a label on the bottom of your WiFi router.

! NOTE: "Open" networks do not use WiFi passwords. Clear or leave this field empty when using the oven on an "Open" network. Additional permissions at the router may be required for use on open networks. Contact your network administrator for assistance.

Channel

The Channel is reported by the WiFi router. It is not changeable on the oven.

NOTE: If you are experiencing connectivity problems, TurboChef recommends setting the WiFi router's channel to 1.

Change the network channel by logging into your router. For help with your WiFi router, contact your network administrator.

MAC IP

The MAC IP is automatically assigned to the embedded wireless device. A visible MAC IP confirms the module is installed properly.

Settings Screen - Volume

Touch "Volume" and use the plus or minus icons to increase or decrease the volume of the oven's speaker. See Figure 44, page 25.

Settings Screen - Date

An accurate date is necessary for ensuring the accuracy of diagnostics and fault condition reporting on the oven.

NOTE: The oven may not retain the date if left unplugged for a prolonged period of time.

To set the date, touch "Date" and enter the date in the following format - MM/DD/YY. Touch the check icon in the bottom-right corner of the screen to save the changes. See Figure 44, page 25.

Settings Screen - Time

An accurate time is necessary for ensuring the accuracy of diagnostics and fault condition reporting.

NOTE: The oven may not retain the time if left unplugged for a prolonged period of time.

NOTE: The clock will not automatically update for Daylight savings time.

To set the time, touch “Time” and enter the time in 24-hour format (8:30 p.m. = 20:30). Touch the check icon in the bottom-right corner of the screen to save the changes. See Figure 44, page 25.

Service Screen

Only qualified service technicians should access the service options, unless otherwise instructed by TurboChef.

MFG Screen

Only qualified service technicians should access the MFG options, unless otherwise instructed by TurboChef.

Edit Mode

Edit Mode allows the operator to:

- Edit the set temperatures.
- Edit item settings, group names, and item names.

Editing can be enabled and disabled from the Options screen (page 25).

NOTE: Top and bottom oven settings are independent of each other. To change the top oven temperature and menu settings, use the upper half of the screen. To change the bottom oven temperature and menu settings, use the bottom half of the screen.

Edit Set Temperature

See Figure 46, page 28.

The menu set temperature should never be changed to compensate for over-cooking or under-cooking. If recipe settings are not cooking as desired, consult your menu developer, authorized distributor, or TurboChef Customer Support.

The set temperature can be edited in the group select screen (Figure 46, Page 28). Touch the temperature icon to increase the Set Temperature by 25°F (15°C). The temperature range is 300–550°F (150–285°C).

Edit Item Settings and Menu/Group/Item Names

See Figure 48, page 28.

To edit settings, menu names, group names, and item names, select a group (Figure 46, page 28) and item (Figure 47, page 28) to edit.

NOTE: Some models may not include multitemperature/menu selection.

1. Menu/Group/Item Name

The menu, group, and item names are only visible if the screen is in the expanded view. Compare Figure 15 to Figure 19. Touch the field you wish to edit and use the onscreen keyboard (Figure 16, page 15) to rename it.

NOTE: Touch the  icon to change the letter case.

NOTE: Touch the ALT icon to access special characters.

NOTE: Touch the &% icon to access symbols.

2. Event %Time

Each item can have up to four events. To set the amount of time for each event, touch the  icon that contains the percentage you wish to change. The time can be set from 0-100% (in 5% increments) for each event.

NOTE: The sum of all events must be 100; otherwise the oven will not allow the changes to be saved.

3. Event %Air

To set the amount of airflow used in each event, touch the  icon that contains the percentage you wish to change. The airflow can be set from 10-100% (in 5% increments) for each event.

4. Increase and Decrease

Touch these icons to increase or decrease the selected %Air or %Time events in 5% increments.

5. Total Cook Time

Displays the total cook time for the item.

6. Set Cook Time Icons

Time can be set from 00:05-99:55 (mm:ss). There are four time icons.

- Clear (or “zero”) the time
- Add 5 seconds
- Add 30 seconds
- Add 60 seconds

7. Cancel

Touch this icon to cancel all changes made to this item and return to the item select screen.

8. Save

Touch this icon to save all changes made to this item and return to the item select screen.

NOTE: While test cooking and developing your recipe settings, it is not necessary to save changes until you are ready to exit the edit recipe screen.

9. Cook

Touch this icon to perform a test cook using the settings displayed on the screen.

NOTE: You may have to allow the oven time to cool down or warm up to the set temperature.

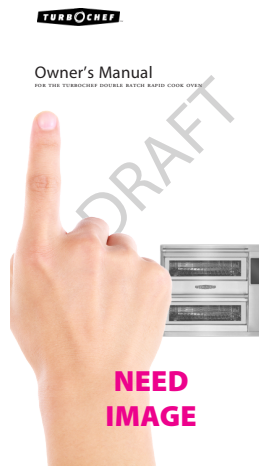

Figure 46: Edit Mode, Group Select

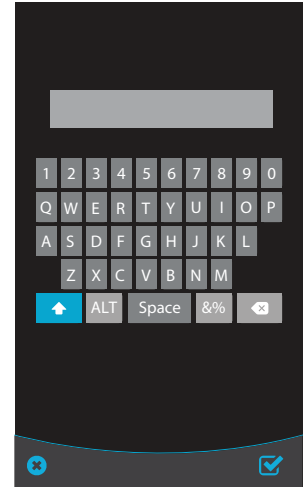

Figure 49: On-Screen Keyboard



Figure 47: Edit Mode, Item Select



Figure 50: Edit Mode, Item Settings - Normal

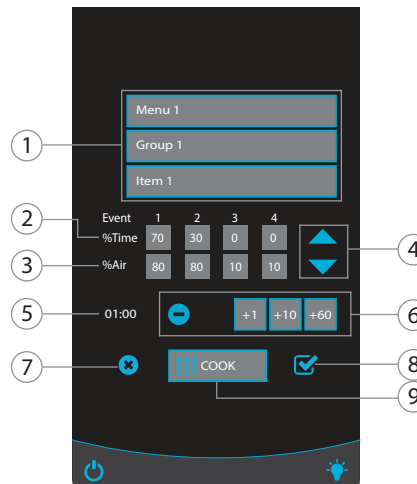

Figure 48: Edit Mode, Item Settings - Expanded

Loading and Saving Menus

NOTE: To load or save a menu, you may need to verify that access to the Load Menu option is turned on. See page 25 for details.

When loading a menu from USB, the menu must be in the BIN (binary) format and the files must be loaded on the root of the USB.

To create a BIN (binary) formatted menu,

1. Using ChefComm, load or create the menu on your computer.
2. Select Oven > Data Transfer > Create Oven (BIN) File.
3. Navigate to where you wish to save the menu.

NOTE: If you are saving the menu to a USB drive and you will use that USB drive to load the menu to the oven, you must save the menu to the root (top level) of the USB drive.

4. Name the file.

NOTE: If your version of ChefComm Pro is lacking these features, contact TurboChef Customer Support to obtain an update.

To load a menu to the oven,

1. When the oven is off or cooling down, insert the USB drive (Figure 51). The oven will automatically detect the device.
2. Touch “Load Menu to Oven” to proceed.
3. If more than one menu is on the USB drive, you will be prompted to pick which menu to load.

To save a menu to a USB drive,

1. When the oven is off or cooling down, insert the USB drive (Figure 51). The oven will automatically detect the device.
2. Touch “Save Menu to USB” to proceed.

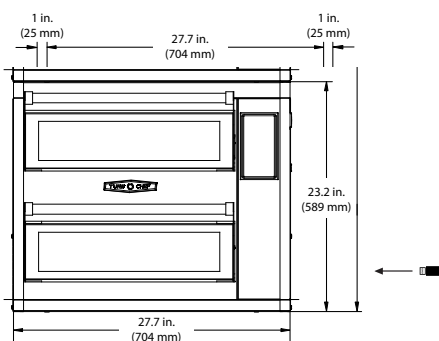



Figure 51: USB Port

Troubleshooting

The following is a list of fault codes and error messages, along with the possible problem(s) that the oven may experience. Please attempt the recommended action before calling Customer Support (800.90TURBO, +1 214.379.6000) or your Authorized Distributor.

NOTE: Many of the issues listed below can occur in either the top or bottom oven. If a fault is specific to the top/bottom oven, it will be appear on the corresponding half (upper/lower) of the display.

If any fault or error message occurs that is not listed below, contact Customer Support (800.90TURBO, +1 214.379.6000).

 **WARNING:** Food, oven door, and oven cavity are hot! Use extreme caution when troubleshooting the issues below.

Issue	Possible Cause(s)	Resolution
No power to oven.	Oven is not plugged in. Main circuit breaker is tripped.	Plug the oven in. Verify the wall circuit breaker is on. Reset the breaker, then power the oven back on.
Oven is not warming up properly.	Oven is in the Off state. Door is not closed. Oven has been switched off at the main circuit breaker. High-limit thermostat tripped.	Touch “Menu” or the power icon. Close the cook cavity door. Turn the oven off and unplug the oven – leave for two minutes. Re-plug in the oven, switch on the isolator/main power supply, and touch “Menu.” Press the button located on the oven rear wall (near the power cord) to reset the high-limit thermostat.
Display reads “Oven Door Open” and alarm sounds.	Food obstruction preventing door from closing. Oven door is open. Door switches require adjustment.	Open the door and remove the obstruction. Open and close the door several times. Call Customer Support.
Oven is not cooking properly.	Oven is not clean. Incorrect group and/or item name was selected for the product. Product was not cooked from correct starting state (for example, chilled or frozen). Product out of specification.	Clean the oven following the cleaning instructions on pages 5-8. Ensure the correct food group and/or item was selected. Ensure the product was in the correct state before being placed in the oven. Ensure the product is exactly the same weight/size as the typical product.

Issue	Possible Cause(s)	Resolution
Steam or smoke is present.	Oven is not clean.	Clean the oven following the cleaning instructions on pages 5-8. Clean the air filter, (step 8, page 6).
Oven is cooling down, shutting down, or making selections on its own.	Debris is on the display. Display is experiencing interference.	Clean the display. Call Customer Support.
Touch response is slow or not detecting touch at all.	Bad boot up when power was cycled.	Unplug the oven for 30 seconds and plug the oven back in and see if the issue is resolved. If not, call Customer Support.
F1: Blower Running Status Bad	Oven power interrupted.	Verify the wall circuit breaker is on. Reset the breaker and then power the oven on. Turn the oven off and unplug the oven – leave for two minutes. Re-plug in the oven, switch on the isolator/main power supply, and select “Menu” and then a set temperature.
F2: Cook Temperature Low	Oven power interrupted. Air nozzles on the top/bottom of the cook cavity are clogged. Oven door is out of alignment. Defective heater. Blower motor not running. Oven not fully warmed up.	Verify the wall circuit breaker is on. Reset the breaker and then power the oven on. During daily cleaning, make sure to unclog the air nozzles on the top/bottom of the cook cavity. Open and close the door several times and verify the door is closed. Reset the high-limit thermostat located on the oven rear wall near the power cord. Call Customer Support. Repeat warmup and allow the oven to idle for five minutes.
F6: EC Temp	Blockage of cool air into the oven. Rear cooling fan exhaust guard(s) clogged.	Remove anything that may be obstructing the flow of cool air into the side/rear oven panels. Make sure the rear fans are free of debris.

North America Limited Warranty

TurboChef Double Batch – North America

The TurboChef rapid cook oven Limited Warranty outlined below is activated upon shipment of your oven. Should you require additional assistance after reviewing the warranty outlined below, please call TurboChef Customer Support at 800.90TURBO.

Limited Warranty

TurboChef Technologies, LLC (“TurboChef”) warrants to you, the purchaser, that under normal use the TurboChef rapid cook oven you have purchased (the “Equipment”) will be free from defects in material and workmanship during the Warranty Period, subject to the terms and conditions set forth herein. The “Warranty Period” is twelve (12) months from the date the Equipment is shipped from TurboChef’s U.S. factory or distribution center. This warranty is conditioned upon you promptly notifying TurboChef of any claims, as provided in the paragraph entitled “Warranty Claims” below, and providing TurboChef with all data and information requested by TurboChef or its service agents in connection with such claims as well as all necessary access to your premises and the Equipment. This warranty is made only to the initial purchaser of the Equipment from TurboChef or its authorized dealer; it is not assignable to subsequent purchasers unless TurboChef consents to such assignment in writing.

Disclaimer of Warranties

Except as provided in the Limited Warranty above, the Equipment is provided “as-is”. TurboChef disclaims all other warranties, express, statutory or implied, including without limitation, the implied warranties of title, non-infringement, merchantability and fitness for a particular purpose. TurboChef does not warrant that the Equipment will meet your specifications or needs. You acknowledge that you are solely responsible for the selection of the Equipment and determining the suitability of the Equipment for your needs.

Warranty Exclusions

Improper Installation, Operation or Maintenance: Equipment that is not installed, operated and maintained in accordance with TurboChef’s rapid cook oven owner’s manual (as may be updated by TurboChef from time to time, the “Manual”), a copy of which is provided to you with the Equipment or otherwise will be furnished to you upon request, is excluded from this warranty. This warranty does not apply to damage or failure which results, in TurboChef’s or its service agent’s sole opinion, from failure to provide a suitable installation and operating environment (including power and HVAC) and facilities as prescribed by the Manual, misuse, abuse, accident, neglect, power failure or power surges (over or under voltage), or to damage or failure from flood, fire, lightning or other natural or man-made disasters, or other Acts of God, or to Equipment that has missing or altered serial numbers.

Modifications and Repair: Equipment that has been modified or altered by persons other than TurboChef or its service agents, or Equipment that has had non-approved devices or connection items attached thereto, is excluded from coverage under this warranty. Repair of the Equipment by anyone other than TurboChef or its authorized service agents will void all warranties on the Equipment.

Accessories: Accessories and parts (collectively “Accessories”) that are consumed in the normal course of Equipment operation or maintenance are excluded from this warranty. Failure of or damage to Equipment or components from the use of non-approved cleaning chemicals, devices or processes is also excluded from this warranty. Accessories may include, but are not limited to, ceramic cooking platters, paddles and approved cleaning chemicals and devices.

Outstanding Invoices: If the full invoiced amount for Equipment purchased has not been paid within forty-five (45) days from the invoice date, then TurboChef will have no obligation to honor this or any other warranty on the Equipment until payment is received in full, including any accrued interest or other charges, has been satisfied, at which time warranty coverage will be reinstated, but the Warranty Period will not be extended.

Warranty Service, Exclusive Remedy

TurboChef will be solely responsible for determining whether or not the Equipment or any component thereof is defective. Defective components covered by this warranty will be repaired or replaced at TurboChef's option without charge to you and such repaired or replacement components will be covered by this warranty for the balance of the Warranty Period. Parts used in the repair of defective components and replacement components may be new, recovered or rebuilt. At its sole option, TurboChef may decide to replace defective Equipment covered by this warranty with new, recovered or rebuilt Equipment of equal or greater capability, and such Equipment will be covered by this Limited Warranty for the balance of the Warranty Period. Defective Equipment and components will become the property of TurboChef. This paragraph states TurboChef's sole and exclusive obligation and liability and your sole and exclusive remedy under this warranty. TurboChef shall not be responsible for a failure to provide warranty services due to causes beyond TurboChef's or its service agents' control.

Warranty Claims

Claims under this warranty must be reported to TurboChef during our normal working hours at 800.90TURBO, or such other reporting service as TurboChef may designate. Upon receipt of the claim and related information and preliminary verification that the claim is valid, TurboChef will promptly notify an authorized service agent to contact you and arrange for an on-site repair visit during the service agent's normal working hours. Any costs incurred by TurboChef or its service agent associated with a service agent being refused or unable to gain access to the Equipment on your premises, or a claim not covered by this warranty, will be charged to you.

Disclaimer of Damages

TurboChef disclaims all incidental, special and consequential damages, including but not limited to loss of use, lost revenue or profits, or substitute use, suffered by you or any third party, whether arising in contract, tort (including negligence), or otherwise, resulting from any breach by TurboChef or its service agents of this warranty, or resulting from the manufacture, use, or defects, of or in the Equipment, even if TurboChef was apprised of the possibility of such damages.

Customer Indemnity

You agree to indemnify, defend and hold TurboChef harmless from all third party claims, demands, judgments, fees and costs directly or indirectly arising out of or related to your use of the Equipment. You further agree to indemnify and hold TurboChef harmless from any incidental, consequential or special damages suffered by you, including lost revenue or profits, loss of use, or substitute use, during periods of Equipment failure or loss of use.

Territory

This warranty is valid in the United States of America, Canada and Puerto Rico.

Governing Law, Entire Warranty

This warranty shall be governed and construed in accordance with the laws of the State of Texas, USA (except with respect to its provisions regarding conflicts of laws). The warranty described herein is the complete and only warranty for Equipment and supersedes all prior oral or written agreements and understandings that may have existed between us relating to Equipment warranties. The terms of this warranty may not be altered, amended or modified except by a signed writing from TurboChef. Any purported alteration, amendment or modification by a service agent or anyone else will not be enforceable against TurboChef.

Charges for Non-Warranty Service or Rejection of Service Visit

In the event that repairs, replacement or service are provided by TurboChef's service agents for work not covered by this limited warranty, customer agrees to pay the service agent directly according to the service agent's normal scale of charges. In the event TurboChef is invoiced by the service agent for services not covered under this extended warranty, TurboChef will invoice customer and customer will pay such invoice based on terms of net 10 days. Customer also agrees to pay any cost incurred by TurboChef or its service agent associated with a service agent responding to a call for service, but then being refused or unable to gain access to the Oven on Customer's premises. Failure to submit payment may, at TurboChef's discretion, result in TurboChef voiding the balance of the warranty. In no event will TurboChef authorize service to a store with an outstanding Non-Warranty invoice.

International Limited Warranty

This Limited Warranty shall apply to the sales of all TurboChef Double Batch ovens (the “Equipment”) manufactured by TurboChef Technologies, LLC (“TurboChef”), and sold to purchasers outside of the United States, Canada, Puerto Rico, Central and South America by an Authorized Distributor of TurboChef International (the “Authorized Distributor”).

Limited Warranty

You, the purchaser (“You”) have entered into a sales contract with the Authorized Distributor for the purchase of the Equipment. This Limited Warranty is made to you by the Authorized Distributor from whom you purchased the Equipment with the support of TurboChef. Subject to the limitations stated below, the Authorized Distributor warrants to You that the quantity and specification of the Equipment delivered to You shall be as set out in the Authorized Distributor’s acceptance of your order and that the Equipment will be free from any material defects in the product and workmanship for twelve (12) months from the date of installation (the “Warranty Period”), subject to the terms and conditions set forth herein.

Disclaimer

You acknowledge that You are solely responsible for the selection of the Equipment and determining the suitability of the Equipment for Your needs. All other warranties, conditions or terms relating to fitness for purpose, quality or condition of the Equipment, whether expressed or implied by statute or common law or otherwise are excluded to the fullest extent permitted by law.

The TurboChef Global Warranty System

This Limited Warranty commences upon delivery of the Equipment to Your premises. The Authorized Distributor will inspect and install the Equipment at Your premises in accordance with TurboChef’s instructions and will record the serial number of the Equipment, Your contact details, the date and location of installation and the results of the Authorized Distributor’s inspection. This information will be entered by the Authorized Distributor into the TurboChef global warranty system and will be used by TurboChef, the Authorized Distributor and its authorized service agents for the provision of the warranty service.

Warranty Service

During the Warranty Period, any materially defective Equipment will be repaired or replaced free of charge at TurboChef’s option provided that:

1. You notify the Authorized Distributor from whom You purchased the Equipment and/or TurboChef as soon as reasonably possible after discovery of a defect and in accordance with the warranty claims procedure set out below;
2. You provide the Authorized Distributor from whom You purchased the Equipment and/or TurboChef with all data and information reasonably requested by TurboChef, the Authorized Distributor or its authorized service agents in connection with Your warranty claim;
3. You make the Equipment available to TurboChef, the Authorized Distributor or its authorized service agents;
4. The Equipment has been installed by an Authorized Distributor and you have provided all necessary information for the Authorized Distributor to register the Equipment in the TurboChef global warranty system;
5. The Equipment has been operated and maintained by You in accordance with TurboChef’s “Owner’s Manual” provided with the Equipment (and as updated by TurboChef);
6. You have not used any non-approved devices, accessories, consumables or parts in conjunction with the Equipment; and
7. Repairs, modifications or alterations have not been attempted other than by TurboChef, an Authorized Distributor or its authorized service agent.

Neither TurboChef nor the Authorized Distributor assumes any liability for damage caused by Your failure to provide a suitable installation and operating environment (including power and HVAC) or facilities as prescribed by the Manual, misuse or abuse or by accident, neglect, power failure or power surges (over or under voltage) howsoever arising.

At its sole option, TurboChef may replace defective Equipment or components with new, recovered or rebuilt Equipment of equal or greater capability, and such Equipment or components will be warranted by the Authorized Distributor for the balance of the Warranty Period. Replaced defective Equipment or components will become the property of TurboChef.

Warranty Claims: Any warranty claim must be made directly in writing either to the Authorized Distributor from whom You purchased the Equipment or to TurboChef at the following address:

TurboChef Technologies, LLC
2801 Trade Center Drive
Carrollton, Texas 75007
Phone: +1 214.379.6000
Fax: +1 214.379.6073

The claim must include the serial number of the Equipment and be received by TurboChef on or before the last day of the Warranty Period. Upon receipt of Your claim, TurboChef will promptly notify an Authorized Distributor or an authorized service agent to contact You, to verify Your claim and, if necessary, to arrange for an on-site repair visit during normal working hours.

Consumables and Parts Used with The Equipment: Neither TurboChef nor the Authorized Distributor assumes any liability for consumables and parts that are used in the normal course of Equipment operation or for failure of or damage to Equipment or components from the use of non-approved cleaning chemicals, devices or processes.

Charges for Service Not Covered by Limited Warranty: In the event that You request and receive repairs, replacement or service not covered by this Limited Warranty, You will be invoiced and must pay the Authorized Distributor or authorized service agent directly according to its normal scale of charges and business terms.

Product Liability: Neither TurboChef nor the Authorized Distributor assumes any liability for any incidental, special or consequential damages, including but not limited to loss of use, lost revenue or profits, or substitute use suffered by You or any third party, whether arising in contract, tort (including negligence), or otherwise resulting from any breach by TurboChef or the Authorized Distributor of the Limited Warranty provided herein.

Exclusive Remedy: This Limited Warranty states the Authorized Distributors and TurboChef's sole and exclusive obligation and liability and your sole and exclusive remedy under this Limited Warranty.

Third Party Rights: The UK Contract (Rights of Third Parties) Act 1999 is excluded from applying to this Limited Warranty and nothing herein confers or purports to confer on any third party any benefit or any right to enforce any term of this Limited Warranty.

Severability: If any item or provision contained in this Limited Warranty or any part of them ("an offending provision") is declared to be or becomes unenforceable, invalid or illegal for any reason whatsoever in any jurisdiction, the other terms and provisions of this Limited Warranty shall remain in full force and effect in that jurisdiction as if it had been executed without the offending provision appearing in it and the entire Limited Warranty shall remain in full force and effect in all other jurisdictions.

Governing Law, Entire, Agreement: This Limited Warranty shall be governed by and construed according to English law. The application of the United Nations Convention on International Sale of Goods to this Limited Warranty is expressly excluded. This Limited Warranty may not be altered, amended or modified by the Authorized Distributor or its service agent, and no representation, alteration, amendment or modification by TurboChef shall be valid unless in a signed form from TurboChef.

For service or information:

WITHIN NORTH AMERICA CALL
Customer Support *at* 800.90TURBO

OUTSIDE NORTH AMERICA CALL
+1 214.379.6000 or Your Authorized Distributor



Part Number: HHD-1001 / Revision G / August 2023
Country Code: NA/EU

Global Operations

2801 Trade Center Drive
Carrollton, Texas 75007 USA
+1 214.379.6000 PHONE
+1 214.379.6073 FAX

Customer Support:

800.90TURBO
+1 214.379.6000
turbochef.com