



THE Eco ST



PERFORMANCE

Utilizing TurboChef's patented technology to rapidly cook food without compromising quality, the Eco ST provides superior cooking performance while requiring less space and consuming less energy.

VENTILATION

- Ventless certification
- EPA 202 test (8 hr):
 - Product: 237 Pepperoni Pizzas
 - Results: 0.64 mg/m³
 - Ventless Requirement: <5.00 mg/m³
- Internal catalytic filtration to limit smoke, grease, and odor emissions.

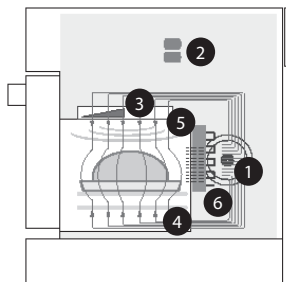

1. Blower Motor
2. Top-launched Microwave
3. Stirred Impinged Air (Top) and Microwave
4. Air Impingement (Bottom)
5. Catalytic Converter
6. Heater
7. Air Filter

Project _____

Item No. _____

Quantity _____

EXTERIOR CONSTRUCTION

- Corrosion-resistant steel outer wrap and door
- Cool-to-touch exterior; all surfaces below 122°F/50°C
- Ergonomic door handle
- 7-inch capacitive touch screen with tempered glass cover

INTERIOR CONSTRUCTION

- 201/304 stainless steel
- Fully welded and insulated cook chamber
- Removable rack and lower jetplate

STANDARD FEATURES

- Single motor vertically circulates air impingement
- Top-launched microwave system
- Stirrer to help ensure even distribution of air and microwave
- Integral recirculating catalytic converter for UL® (KNLZ) listed ventless operation
- External air filtration
- Smart menu system capable of storing unlimited recipes
- Customizable menu settings via Wi-Fi (additional fees apply), USB, or manual entry
- Flash firmware updates via USB
- Single or dual-temperature interface
- Self-diagnostics for monitoring oven components and performance
- Smart Voltage Sensor Technology* (U.S. only)
- Stackable (requires stacking kit)
- Includes plug and cord (6 ft. nominal)
- Warranty – 1 year parts and labor
- Open Kitchen™ ready

CONNECTIVITY PART NUMBERS

- MDD-1001 - Initial Equipment
- MDD-1002 - Additional Equipment
- MDD-1003 - Additional Year (PhD SAAS)



COMES WITH STANDARD ACCESSORIES

- 1 Bottle Oven Cleaner (103180)
- 1 Bottle Oven Guard (103181)
- 2 Trigger Sprayers (103182)
- 1 Aluminum Paddle (i1-9716)
- 1 Grill Plate (i1-9808)

CERTIFICATIONS



This product conforms to the ventilation recommendations set forth by NFPA96 using EPA202 test method.

* Smart Voltage Sensor Technology does not compensate for lack of or over voltage situations. It is the responsibility of the owner to supply voltage to the unit according to the specifications on the back of this sheet.

† Ventless certification is for all food items except for foods classified as "fatty raw proteins." Such foods include bone-in, skin-on chicken, raw hamburger meat, raw bacon, raw sausage, steaks, etc. If cooking these types of foods, consult local HVAC codes and authorities to ensure compliance with ventilation requirements.

If you have questions regarding ventless certifications or local codes, please email ventless.help@turbochef.com

TurboChef reserves the right to make substitutions of components or change specifications without prior notice.



DIMENSIONS		
Height	23.78	604 mm
Width	14.25"	362 mm
Depth	22.06"	560 mm
Weight	130 lb.	59 kg
Cook Chamber		
Height / Usable Height	7.2" / 5.7"	183 mm / 145 mm
Width	12.5"	318 mm
Depth / Usable Depth	10.5" / 9.3"	267 mm / 236 mm
Volume / Usable Volume	0.54 cu.ft. / 0.38 cu.ft.	15.3 liters / 10.7 liters
Wall Clearance (Oven not intended for built-in installation)		
Top	5"	127 mm
Sides	1"	25 mm
ELECTRICAL SPECIFICATIONS – SINGLE PHASE		
US/CANADA ECS-9500-1: Stainless Steel ECS-9500-2: Traffic Red (RAL-3020) ECS-9500-3: Yellow Green (RAL 6018) ECS-9500-4: Pure White (RAL 9010) ECS-9500-5: Jet Black (RAL 9005) ECS-9500-6: Blue (Custom)	208/240 VAC, 60 Hz, 30 A Max Input: 6.0 kW* MW: 3.2 kW HTR: 6.0 kW Plug: NEMA 6-30P	
EUROPE (UK) ECS-9500-13-UK: Stainless Steel ECS-9500-14-UK: Traffic Red (RAL-3020) ECS-9500-15-UK: Yellow Green (RAL 6018) ECS-9500-16-UK: Pure White (RAL 9010) ECS-9500-17-UK: Jet Black (RAL 9005) ECS-9500-18-UK: Blue (Custom)	230 VAC, 50 Hz, 27 A Max Input: 6.8 kW* MW: 3.2 kW HTR: 6.0 kW Plug: IEC 309, 3-pin	
JAPAN (JK) ECS-9500-25-JK: Stainless Steel ECS-9500-26-JK: Traffic Red (RAL-3020) ECS-9500-27-JK: Yellow Green (RAL 6018) ECS-9500-28-JK: Pure White (RAL 9010) ECS-9500-29-JK: Jet Black (RAL 9005) ECS-9500-30-JK: Blue (Custom)	200 VAC, 50 Hz, 30 A Max Input: 6.2 kW* MW: 3.2 kW HTR: 6.0 kW Plug, NEMA L6-50, PSE, 3-blade	
JAPAN (JK) ECS-9500-31-JK : Stainless Steel ECS-9500-32-JK : Traffic Red (RAL-3020) ECS-9500-33-JK : Yellow Green (RAL 6018) ECS-9500-34-JK : Pure White (RAL 9010) ECS-9500-35-JK : Jet Black (RAL 9005) ECS-9500-36-JK : Blue (Custom)	200 VAC, 60 Hz, 30 A Max Input: 6.2 kW* MW: 3.2 kW HTR: 6.0 kW Plug, NEMA L6-50, PSE, 3-blade	

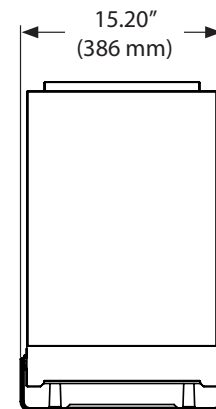
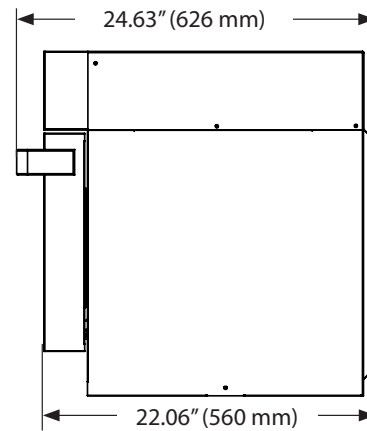
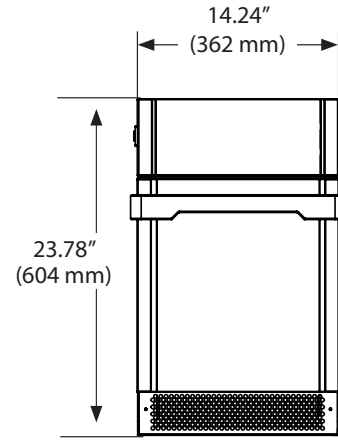











Continued on next page...

* Under normal operation, the oven will not exceed the max input value.

TurboChef recommends installing a type D circuit breaker for European installations.



ELECTRICAL SPECIFICATIONS – SINGLE PHASE	
BRAZIL (BK) ECS-9500-37-BK: Stainless Steel ECS-9500-38-BK: Traffic Red (RAL-3020) ECS-9500-39-BK: Yellow Green (RAL 6018) ECS-9500-40-BK: Pure White (RAL 9010) ECS-9500-41-BK: Jet Black (RAL 9005) ECS-9500-42-BK: Blue (Custom)	220 VAC, 60 Hz, 28 A Max Input: 6.2 kW* MW: 3.2 kW HTR: 6.0 kW Plug: IEC 309, 3-pin 
LATIN AMERICA (LA) - includes cleaner and guard ECS-9500-49-LA: Stainless Steel ECS-9500-50-LA: Traffic Red (RAL-3020) ECS-9500-51-LA: Yellow Green (RAL 6018) ECS-9500-52-LA: Pure White (RAL 9010) ECS-9500-53-LA: Jet Black (RAL 9005) ECS-9500-54-LA: Blue (Custom)	220 VAC, 60 Hz, 28 A Max Input: 6.2 kW* MW: 3.2 kW HTR: 6.0 kW Plug: NEMA 6-30P 
LATIN AMERICA (LA) - without cleaner and guard ECS-9500-55-LA: Stainless Steel ECS-9500-56-LA: Traffic Red (RAL-3020) ECS-9500-57-LA: Yellow Green (RAL 6018) ECS-9500-58-LA: Pure White (RAL 9010) ECS-9500-59-LA: Jet Black (RAL 9005) ECS-9500-60-LA: Blue (Custom)	220 VAC, 60 Hz, 28 A Max Input: 6.2 kW* MW: 3.2 kW HTR: 6.0 kW Plug: IEC 309, 5-pin 
ELECTRICAL SPECIFICATIONS – MULTIPHASE	
EUROPE DELTA (ED) ECS-9500-67-ED: Stainless Steel ECS-9500-68-ED: Traffic Red (RAL-3020) ECS-9500-69-ED: Yellow Green (RAL 6018) ECS-9500-70-ED: Pure White (RAL 9010) ECS-9500-71-ED: Jet Black (RAL 9005) ECS-9500-72-ED: Blue (Custom)	230 VAC, 50 Hz, 20 A Max Input: 6.2 kW* MW: 3.2 kW HTR: 6.0 kW Plug: IEC 309, 4-pin 
EUROPE WYE (EW) ECS-9500-7-EW: Stainless Steel ECS-9500-8-EW: Traffic Red (RAL-3020) ECS-9500-9-EW: Yellow Green (RAL 6018) ECS-9500-10-EW: Pure White (RAL 9010) ECS-9500-11-EW: Jet Black (RAL 9005) ECS-9500-12-EW: Blue (Custom)	400 VAC, 50 Hz, 16 A Max Input: 6.2 kW* MW: 3.2 kW HTR: 6.0 kW Plug: IEC 309, 5-pin 
AUSTRALIA (AU) ECS-9500-19-AU: Stainless Steel ECS-9500-20-AU: Traffic Red (RAL-3020) ECS-9500-21-AU: Yellow Green (RAL 6018) ECS-9500-22-AU: Pure White (RAL 9010) ECS-9500-23-AU: Jet Black (RAL 9005) ECS-9500-24-AU: Blue (Custom)	400 VAC, 50 Hz, 16 A Max Input: 6.2 kW* MW: 3.2 kW HTR: 6.0 kW Plug: Clipsal, 5-pin 
JAPAN (JD) ECS-9500-73-JD: Stainless Steel ECS-9500-74-JD: Traffic Red (RAL-3020) ECS-9500-75-JD: Yellow Green (RAL 6018) ECS-9500-76-JD: Pure White (RAL 9010) ECS-9500-77-JD: Jet Black (RAL 9005) ECS-9500-78-JD: Blue (Custom)	200 VAC, 50 Hz, 20 A Max Input: 6.2 kW* MW: 3.2 kW HTR: 6.0 kW Plug: NEMA L6-50, PSE, 4-blade 

JAPAN (JD) ECS-9500-101-JD : Stainless Steel ECS-9500-102-JD : Traffic Red (RAL-3020) ECS-9500-103-JD : Yellow Green (RAL 6018) ECS-9500-104-JD : Pure White (RAL 9010) ECS-9500-105-JD : Jet Black (RAL 9005) ECS-9500-106-JD : Blue (Custom)	200 VAC, 60 Hz, 20 A Max Input: 6.2 kW* MW: 3.2 kW HTR: 6.0 kW Plug: NEMA L6-50, PSE, 4-blade 
KOREA/MIDDLE EAST WYE (KW) ECS-9500-61-KW: Stainless Steel ECS-9500-62-KW: Traffic Red (RAL-3020) ECS-9500-63-KW: Yellow Green (RAL 6018) ECS-9500-64-KW: Pure White (RAL 9010) ECS-9500-65-KW: Jet Black (RAL 9005) ECS-9500-66-KW: Blue (Custom)	400 VAC, 60 Hz, 16 A Max Input: 6.2 kW* MW: 3.2 kW HTR: 6.0 kW Plug: IEC 309, 5-pin 
KOREA/MIDDLE EAST WYE (SD) ECS-9500-43-SD: Stainless Steel ECS-9500-44-SD: Traffic Red (RAL-3020) ECS-9500-45-SD: Yellow Green (RAL 6018) ECS-9500-46-SD: Pure White (RAL 9010) ECS-9500-47-SD: Jet Black (RAL 9005) ECS-9500-48-SD: Blue (Custom)	230 VAC, 60 Hz, 20 A Max Input: 6.2 kW* MW: 3.2 kW HTR: 6.0 kW Plug: IEC 309, 4-pin 
SHIPPING INFORMATION	
U.S.: All ovens shipped within the U.S. are packaged in a double-wall corrugated box banded to a wooden skid. International: All International ovens shipped via Air or Less than Container Loads are packaged in wooden crates.	
Box size: 33" x 24" x 34" (838 mm x 610 mm x 864 mm) Crate size: 33" x 24" x 34" (838 mm x 610 mm x 864 mm) Item class: 110 NMFC #26710 HS code 8419.81	
Approximate boxed weight: 163 lb. (74 kg) / Approximate crated weight: 191 lb. (87 kg)	
Minimum entry clearance required for box: 34.5" (876 mm) Minimum entry clearance required for crate: 34.5" (876 mm)	

* Under normal operation, the oven will not exceed the max input value.

 **TurboChef recommends installing a type D circuit breaker for European installations.**